

Environment responsive type**TF • TE • TD • TK • TW****Thermometers with Electric Contact****Outline**

These thermometers equipped with electric contacts which can be set to any position. These are using organic liquids and/or inert gases as the enclosed medium to meet a pollution policy. This catalog classifies the thermometers by electric contact type into thermometers with microswitch and thermometers with contact switch and by case construction into indoor use type, drip-proof type, explosion-proof type, and water-proof type.

* Please select the temperature range with your common temperature should be 75% or less. Furthermore, please ensure that the wetted parts materials listed are suitable for the use against measuring gas or liquid.

**Specifications****Manufacturing temperature range:**

-70 to 50°C → 0 to 650°C

Electric contact type:

With micro switch
With contact switch

Construction:

Indoor use (With contact switch)
Drip-proof type (With micro switch)
Explosion-proof type (d2G4)
Water-proof (Application for transformer)

Size:

φ 75, φ 100, φ 150

Mounting:

Remote surface mounting



Remote panel mounting
(Mounting hole • Mounting clamp)

**Bulb / Connection mounting:**

SUS304

Lead parts material:

Capillary: SUS304 or SUS316
Armored tube: SUS430

Connection:

R $\frac{1}{2}$, R $\frac{3}{4}$, $\frac{1}{2}$ NPT, G $\frac{1}{2}$ B, G $\frac{3}{4}$ B
JIS10K20ARF, JIS10K25ARF
ANSI1B150RF, ANSI1B300RF

* For other connections, please contact us.

Accuracy:

Indicator accuracy Within $\pm 2\%$ F.S.
Reproducibility Within $\pm 2\%$ F.S.

Selection of the specifications of thermometers with electric contact

1. Features of switch

Micro switch

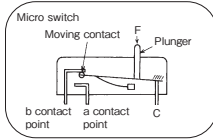

A micro switch is able to handle a high electric rating and is safe from vibrations. It is available for various control applications, in addition to transmitting an alarm.

Contact switch

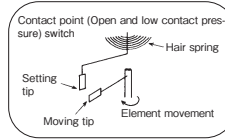

Contact point is mainly used to issue a warning, including a buzzer and flashing lamp. However, it can also be used for large capacity ON/OFF control through a relay. The contacting tip is made of a high melting point alloy of platinum and osmium. The contact point open state, should normally be used in the open state.

Size	φ 100, φ 150		φ 75		φ 75, φ 100, φ 150	
Type	Micro switch				Contact switch	
Characteristic	Resistance load		Inductive load*		Resistance load	
	125 V AC 5 A		125 V AC 3 A		125 V AC 5 A	
	250 V AC 5 A		250 V AC 3 A		125 V AC 3 A	
	30 V DC 5 A		30 V DC 3 A		250 V AC 2 A	
	125 V DC 0.4 A		125 V DC 0.4 A		30 V DC 4 A	
Rating	250 V AC 3 A		30 V DC 3 A		30 V DC 3 A	
	125 V DC 0.4 A		125 V DC 0.4 A		125 V DC 0.4 A	
	* AC: Power factor 0.4 or more DC: Time-contact 7ms or less		* AC: Power factor 0.4 or more DC: Time-contact 7ms or less		Resistance load	
					100 V AC 0.5 A	
					200 V AC 0.25 A	
					100 V DC 0.05 A	
					200 V DC 0.025 A	
Withstand voltage	1500V AC 1minute		1000V AC 1minute		1000V AC 1minute	

The insulation resistance (micro contact) should be 100MΩ or more as measured with a 500V DC megger.

*The minimum load of the micro contact is 800mW and that of the contact point is 1W.

2. Explosion-proof temperature switch

Electric equipment used in hazardous areas when inflammable gas or explosive liquids exist must be explosion-proof products which have received national approval.

Select explosion-proof thermometers with electric contact for use in factories, indoor storage sites, outdoor tank storage, indoor tank storage, general handling sites, and transport handling sites which handle dangerous materials.

3. Compensation system by installation site

When the ambient temperature of a temperature gauges changed, the liquid sealed in the indicator and capillary tube of filled system thermometer expands or contracts and causes an indication error. To compensate for this error, the following compensation two systems are available.

(1) Bimetal compensation

· When the temperature is changed in the same at the indicator and capillary tubes.

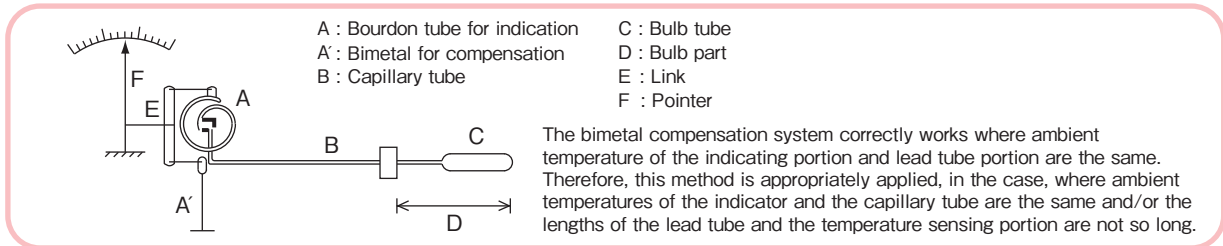

(2) Lead compensation

- ① When the temperature change around the indicator is small and the temperature change around the capillary tubes is large and vice versa.
- ② When the capillary tubes are used under various ambient temperatures.
- ③ When a part of the capillary tubes is heated.
- ④ When measuring the liquid temperature in the tank with different temperature distribution. Or when the height of the liquid level changes.

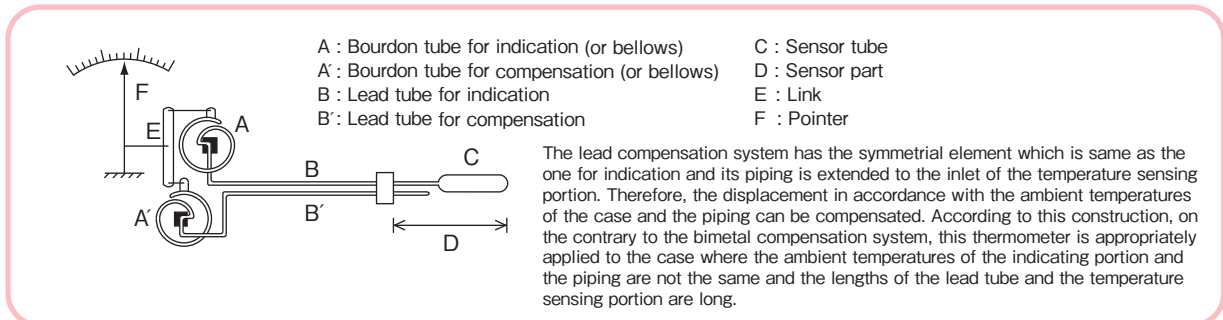
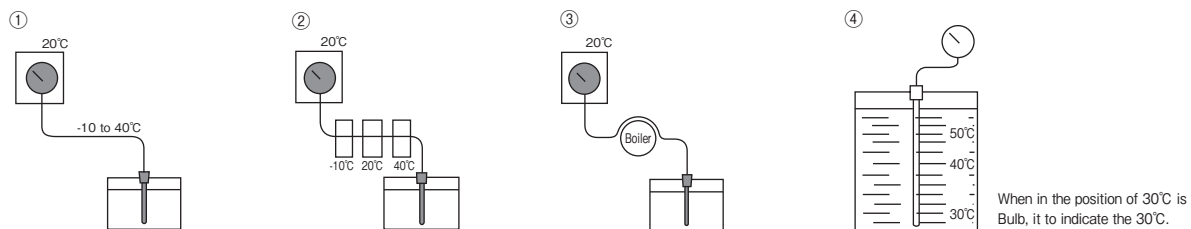

Selection of the specifications of thermometers with electric contact

4. Temperature range (Scale range)

- The upper limit of the normal temperature should be selected temperature range to be 75% or less of the temperature span.
- The instrument itself is active even though the thermometer is not used, including temperature measurement from the time of manufacture.
- When the temperature exceeds the temperature range, it may cause the temperature gauge to break.

Normal usage range

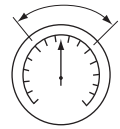

If the gauges will cross the equator or pass through cold regions during shipment, or will be stored in a cold region, careful attention is required.

5. Mounting type of bulb

Union type

- Standard spec.

	<p>By tightening the fixing screw, the bulb is fixed to the connecting screws so that its position does not change.</p>	<p>Maximum allowable working pressure of union type is Less than 200g → 2MPa Over 200g → 1MPa (If the pressure is higher than the above, a thermowell should be provided.)</p>
--	---	---

Slide type

- When the bulb position must be adjusted due to changing of the position of the fluid to be measured in a tank or other vessel.
- When thermowell is provided or the bulb must be inserted all the way to the bottom.

	<p>By tightening the gasket with fixing screw, bulb can be fixed at any position.</p>	<p>Maximum allowable working pressure of slide type is 0.3MPa (If the pressure is higher than the above, a thermowell should be provided.)</p>
--	---	---

Plain type

- When a long bulb is inserted into the thermowell, it does not have to be fixed.
- Only remote type is manufactured.

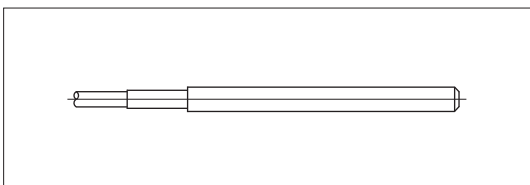

6. Bulb minimum insertion length

- The minimum bulb insertion length is decided according to the type, temperature range and bulb diameter. Decide the bulb length within the range between the minimum insertion length and the maximum insertion length. Make sure that the bulb is inserted into the liquid under measurement up to the screws, flange, or other connecting parts.

[Caution]

If the bulb is not inserted into the liquid under measurement up to the screws or flange, an indication error may occur.

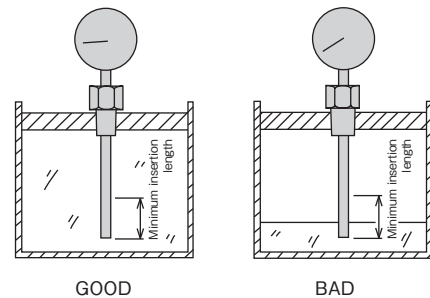

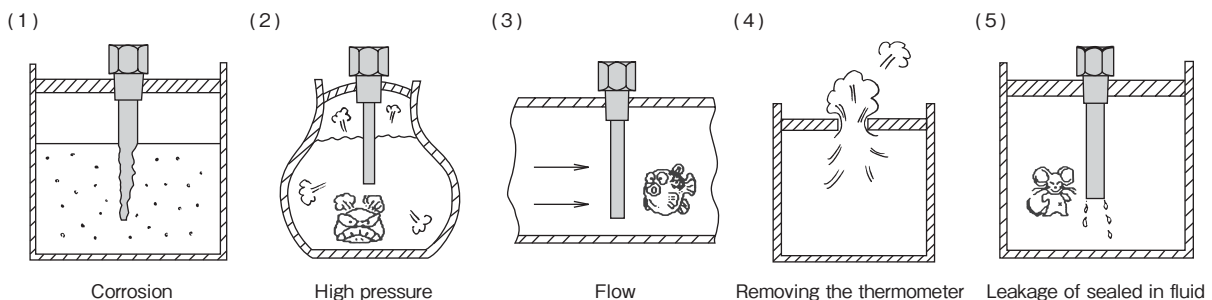

7. Thermowell necessary conditions

- (1) For corrosive fluids, a thermowell made of a suitable material is necessary.
- (2) For high pressure, a thermowell suited to the operating pressure must be used.
- (3) When the fluid flows, a thermowell suitable for the flow speed must be used.
- (4) When the fluid leaks when the thermometer is removed, a thermowell is convenient for maintenance.
- (5) When the liquid in the thermometer leaks from the bulb and is harmful, a thermowell must be used.

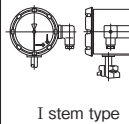
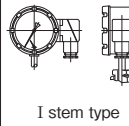
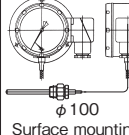
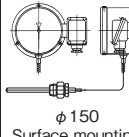
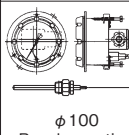
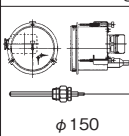
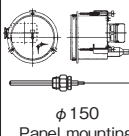
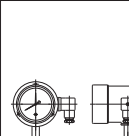
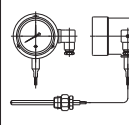
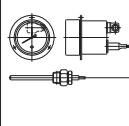
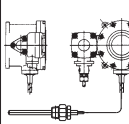

Thermometers with electric contact

1. Thermometer with micro switch

Mounting	Sensing method	Manufacturing range	Compensation	Max. lead length	Dial size (mm)	Model	Page	
Drip-proof type (Non-explosion proof)	 I stem type	Liquid filled type	-70 to 50°C →0 to 300°C	Lead compensation	—	100	TF14	9
	 I stem type	Gas filled type	0°C to 400°C 0°C to 500°C 0°C to 600°C	Bimetal compensation			TE14	10
	 Surface mounting φ 100	Liquid filled type	-70 to 50°C →0 to 300°C	Lead compensation	15m	100	TF54	12
		Gas filled type	0°C to 400°C 0°C to 500°C 0°C to 600°C	Bimetal compensation	20m		TE54	14
	 Surface mounting φ 150	Liquid filled type	-70 to 50°C →0 to 300°C	Lead compensation	20m	150	TF56	12
		Gas filled type	0°C to 400°C 0°C to 500°C 0°C to 600°C	Bimetal compensation			TE56	14
	 Panel mounting φ 100	Liquid filled type	-70 to 50°C →0 to 300°C	Lead compensation	15m	100 (Hole type)	TF64	13
						100 (Clamp type)	TF74	
	 Panel mounting φ 150	Gas filled type	0°C to 400°C 0°C to 500°C 0°C to 600°C	Bimetal compensation	20m	100 (Hole type)	TE64	15
						100 (Clamp type)	TE74	
	 Panel mounting φ 150	Liquid filled type	-70 to 50°C →0 to 300°C	Lead compensation	20m	150 (Hole type)	TF66	13
							150 (Clamp type)	
 Panel mounting φ 150	Gas filled type	0°C to 400°C 0°C to 500°C 0°C to 600°C	Bimetal compensation		150 (Hole type)	TE66	15	
					150 (Clamp type)	TE76		
Indoor type (Non-explosion proof)		Liquid filled type	-70 to 50°C →0 to 300°C	Lead compensation	10m	75	TF53	11
							TF63	
Explosion-proof type		Liquid filled type	-70 to 50°C →0 to 300°C	Lead compensation	20m	—	TD25	18
		Gas filled type	0°C to 400°C 0°C to 500°C 0°C to 600°C	Bimetal compensation			TD21	19

Thermometers with electric contact

2. Thermometer with contact switch

Mounting	Sensing method	Manufacturing range	Compensation	Max. lead length	Dial size (mm)	Model	Page				
Drip-proof type (Non-explosion proof) Surface mounting Panel mounting (Hole mounting) Panel mounting (Clamp mounting)	Liquid filled type Gas filled type	-70 to 50°C →0 to 650°C	Lead compensation→ 20m Bimetal compensation→*5m Lead compensation is for φ 150 only		75	TK53	23				
					100	TK54					
					150	TK56					
									75	TK63	24
									100	TK64	
									150	TK66	
					75	TK73	25				
					100	TK74					
					150	TK76					
Explosion-proof type	Liquid filled type Gas filled type	-70 to 50°C →0 to 600°C	Bimetal compensation	10m	—	TD10	27				
For transformer Indoor use Water-proof type	Liquid filled type Gas filled type	-70 to 100°C →0 to 500°C	Bimetal compensation	5m	75	TW83	31				
					100	TW84					
					100	TW54	32				

* When the range is 0 to 400°C or more, can be manufactured up to 20m.

Connection / Bulb specifications

1. Without thermowell

	Connection		Bulb outer DIA.	Note
	Screw type	Flange type		
Union type	<p>Max. operating pressure: 2MPa for less than 200°C, 1MPa for 200°C or over</p>		8	Direct type and slide type not available.
			10	
Slide type	<p>Max. operating pressure: 0.3MPa</p>		12	
			13	
Plain type	<p>Remote type only. Direct type not available.</p>		16	T = 1/2 not available. Slide type not available.

2. With thermowell

	Connection		Thermowell outer DIA.	Bulb outer DIA.	Note
	Screw type	Flange type			
Standard type			12	8	
			15	10	
Double socket type			19	13	T = 1/2 not available.
			23	16	T = 1/2 not available. Welding type well not available
Double socket type			Taper 19 / 23	13	T = 1/2 not available. Welding type well not available

3. Connection standard

	Screw type	Flange type
Standard connection	R 1/2, R 3/4, 1/2NPT, G 1/2B, G 3/4B (Fixing screw only = W22 thread 14)	JIS 10K 20ARF JIS 10K 25ARF ANSI 1B 150RF ANSI 1B 300RF

Other screws and flanges in addition to those shown at above are available.
Contact NKS for details.

Scale shape

Refer to the manufacturing specifications of the respective models for the graduations of the respective models.

Range °C	Scale division and number entry position	75	100	150
0~ 50		○	○	○
0~100		○	○	○
0~500		○	○	○
0~ 60		○	—	—
		—	○	○
0~120		○	○	○
0~ 80		○	○	○
0~400		○	○	○
0~150		○	—	—
		—	○	○
0~200		○	○	○
0~250		○	○	○
0~300		○	—	—
		—	○	○
0~600		○	—	—
		—	○	○
-10~ 50		○	○	○
-20~100		○	○	○
-10~100		○	○	○
-30~ 50		○	○	○
-50~ 50		○	○	○
-70~ 50		○	○	○
-70~100		○	○	○

●Scale angle is 250° to 270°.

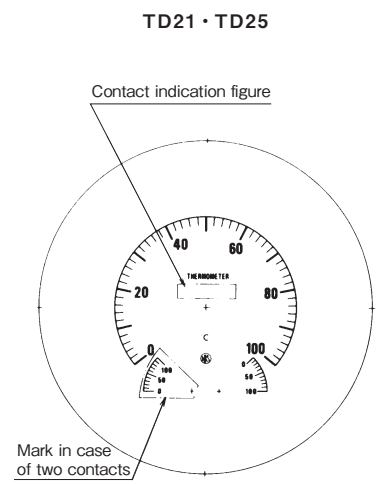
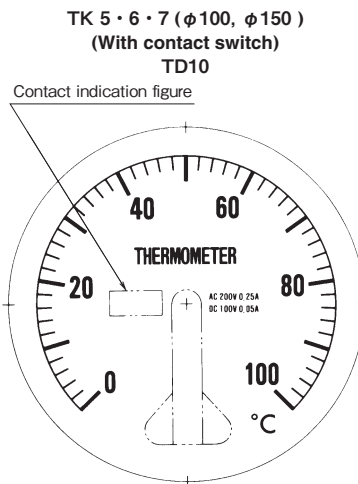
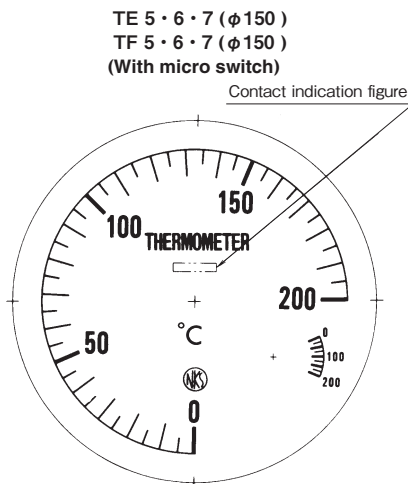

Contact point type	Mark	Contact indication figure
Upper limit type	H	<input type="checkbox"/> OFF <input type="checkbox"/> ON
Lower limit type	L	<input type="checkbox"/> ON <input type="checkbox"/> OFF
Upper & lower limit type	H L	<input type="checkbox"/> OFF <input type="checkbox"/> ON <input type="checkbox"/> ON <input type="checkbox"/> OFF

Ground: White

Entry: Black, red for minus graduation lines and figures.

Type of contact and wiring system

With micro switch

1. Upper limit type with one contact · H (①-② wired)

When the temperature rises to the set point or upper, the contact points operate to turn the circuit ON. The OFF point when the temperature drops is only the amount of the dead band inherent to the micro switch.

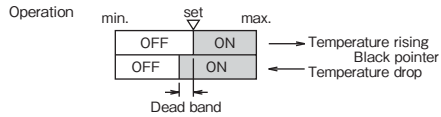

Wiring

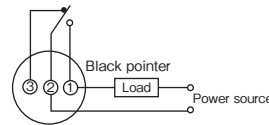

This type can also be used as a lower limit type (②-③ wired), but the setting must be corrected by the amount of the dead band.

2. Lower limit type with one contact · L (②-③ wired)

When the temperature decreases to the set point or lower, the contact points operate to turn the circuit ON. The OFF point when the temperature rises is only the amount of the dead band inherent to the micro switch.

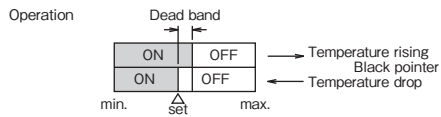

Wiring

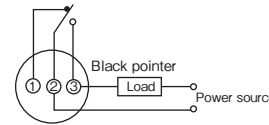

This type can also be used as an upper limit type (①-② wired), but the setting must be corrected by the amount of the dead band.

3. Upper & lower limit type with two contacts · H L

(φ 100: ①-② wired, ③-④ wired)
(φ 150: ①-② wired, ⑤-⑥ wired)

This is a combination of the upper limit type and the lower limit type. Each type operates independently. See items 1 and 2 above for their operation.

Wiring

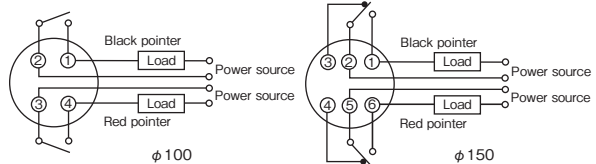

4. Upper limit type with two contacts · 2H

(φ 100: ①-② wired, ③-④ wired)
(φ 150: ①-② wired, ④-⑤ wired)

This is a combination of two upper limit types. Each type operates independently. See item 1 for its operation.

Wiring

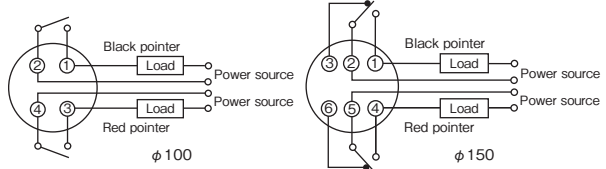

5. Lower limit type with two contacts · 2L

(φ 100: ①-② wired, ③-④ wired)
(φ 150: ②-③ wired, ⑤-⑥ wired)

This is a combination of two lower limit types. Each type operates independently. See item 2 for their operation.

Wiring

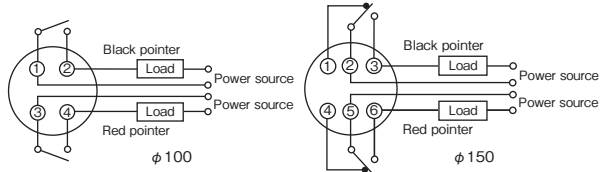

6. Center parts setting type with two contacts · HLR

This is a series combination of one upper limit type and one lower limit type. When both contact points are ON, the circuit turns ON.

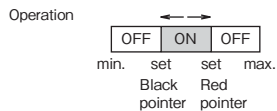

Wiring

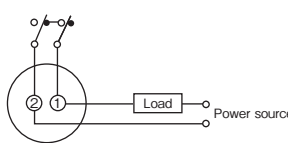

With contact switch

1. Upper limit type with one contact · H

When the temperature rises to the set point or upper, the contact points operate to turn the circuit ON.

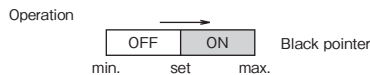

Wiring

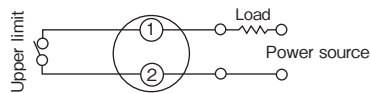

2. Lower limit type with one contact · L

When the temperature decreases to the set point or lower, the contact points operate to turn the circuit ON.

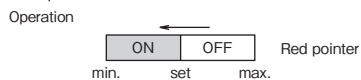

Wiring

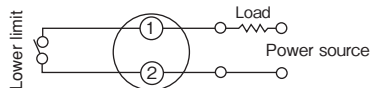

3. Upper & lower limit type with two contacts · H L

This is a combination of the upper limit type and lower limit type with 2 circuits, but these circuits do not operate independently because of the common pole.

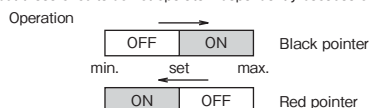

Wiring

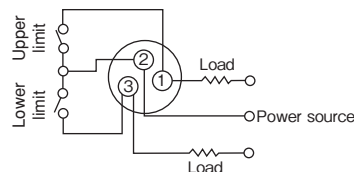

Thermometers with Micro Switch

<Direct I type>

TF14

Liquid filled dial thermometer

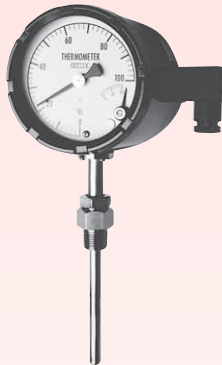

Dimensions

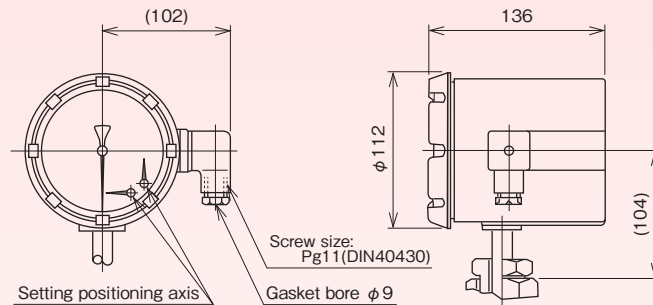

Specifications

Item		Description	
Manufacturing range		-70 to 50°C → 0 to 300°C	
Case		Construction: Drip-proof / Equivalent to IP33, Material: AC7A, Finish: Black	
Wetted parts material		Bulb: SUS304, Connection / Flange: SUS304	
Switch		Micro switch	Electric rating
Number of contacts		One contact (SPDT) / Two contacts (SPSTx2)	Resistance load Inductive load*
Setting		Internal adjustment	125V AC 5A 125V AC 3A
Compensation		Lead compensation	250V AC 5A 250V AC 3A
Connection		R $\frac{1}{2}$, R $\frac{3}{4}$, $\frac{1}{2}$ NPT, G $\frac{1}{2}$ B, G $\frac{3}{4}$ B	30V DC 5A 30V DC 3A
Flange		$\frac{1}{2}$ is not available with ϕ 16 bulb and ϕ 19, ϕ 23 thermowell.	125V DC 0.4A 125V DC 0.4A
Flange		JIS10K20ARF, JIS10K25ARF, ANSI1B15ORF, ANSI1B30ORF	* AC: Power factor 0.4 or more DC: Time-contact 7ms or less
Connection	Without thermowell	Union type	Slide type is not available.
	With thermowell	Double socket union type: R $\frac{1}{2}$, $\frac{1}{2}$ NPT (Connection)	
Accuracy	Indication	Within $\pm 2\%$ F.S. (No load to contact)	
	Reproducibility	Within $\pm 2\%$ F.S.	
	Setting	Within $\pm 3\%$ F.S.	
Dead band		Within 6%F.S.	
Ambient temperature error		Within $\pm 2\%$ F.S. /15°C	

Range / Bulb DIA. / Bulb length

Range °C	Minimum graduation °C	Bulb length (L) mm					Maximum
		Minimum insertion length					
		d = ϕ 8	d = ϕ 10	d = ϕ 12	d = ϕ 13	d = ϕ 16	
-70~ 50	2	160	110	90	75	65	500
-70~100	5	125	90	75	65	60	
-50~ 50	2	180	120	95	85	70	
-30~ 50	2	215	140	110	95	80	
-20~100	2	160	110	90	75	65	
-10~100	2	170	115	95	80	70	
-10~ 50	1	265	170	130	110	90	
0~ 50	1	305	190	145	125	100	
~ 60	1	265	170	130	110	90	
~ 80	2	245	155	120	105	85	
~100	2	205	135	105	90	75	
~120	2	180	120	95	85	70	
~150	2	155	105	85	75	65	
~200	5	110	80	70	60	55	
~250	5	100	75	65	60	55	
~300	5	90	70	60	55	50	

- The above lengths are the minimum necessary of the bulb to be inserted into the fluid to be measured.
- Bulb length should be over the above length and specified in 5mm steps.

The above minimum insertion length is the length without thermowell.
With thermowell, 25mm is added to the above length.

Thermometers with Micro Switch

TE14

<Direct I type>

Gas filled dial thermometer

Corresponds to high temperature

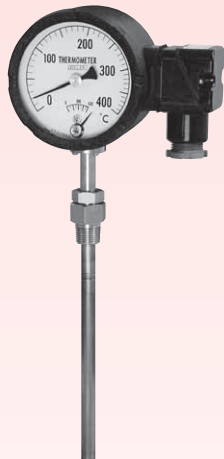

Dimensions

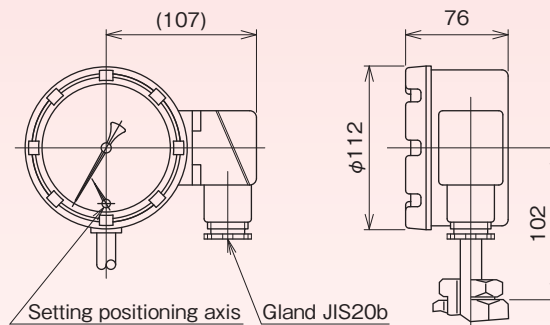

Specifications

Item		Description	
Manufacturing range		0 to 400°C, 0 to 500°C, 0 to 600°C	
Case		Construction: Drip-proof / Equivalent to IP43, Material: AC7A, Finish: Black	
Wetted parts material		Bulb: SUS304, Connection / Flange: SUS304	
Switch		Micro switch	
Number of contacts		One contact (SPDT)	
Setting		Internal adjustment	
Compensation		Bimetal compensation (Indication only)	
Connection		R $\frac{1}{2}$, R $\frac{3}{4}$, $\frac{1}{2}$ NPT, G $\frac{1}{2}$ B, G $\frac{3}{4}$ B $\frac{1}{2}$ is not available with ϕ 16 bulb and ϕ 19, ϕ 23 thermowell.	
Flange		JIS10K20ARF, JIS10K25ARF, ANSI1B15ORF, ANSI1B30ORF	
Connection	Without thermowell	Union type	Slide type is not available.
	With thermowell	Double socket union type: R $\frac{1}{2}$, $\frac{1}{2}$ NPT (Connection)	
Accuracy	Indication	Within $\pm 2.5\%$ F.S. (0 to 400°C), within $\pm 2\%$ F.S. (0 to 500°C, 0 to 600°C)	
	Reproducibility	Within $\pm 2.5\%$ F.S. (0 to 400°C), within $\pm 2\%$ F.S. (0 to 500°C, 0 to 600°C)	
	Setting	Within $\pm 4.5\%$ F.S. (0 to 400°C), within $\pm 4\%$ F.S. (0 to 500°C, 0 to 600°C)	
Dead band		Within $\pm 11\%$ F.S. (0 to 400°C), within $\pm 10\%$ F.S. (0 to 500°C, 0 to 600°C)	
Ambient temperature error		Within $\pm 2.5\%$ F.S. / 15°C (0 to 400°C), within $\pm 2\%$ F.S. / 15°C (0 to 500°C, 0 to 600°C)	
Indication dial angle		250° (0 to 400°C), 270° (0 to 500°C, 0 to 600°C)	

●Other screws and flanges are manufactured. Please contact NKS for details.

Range / Bulb DIA. / Bulb length

Range °C	Minimum graduation °C	Bulb length (L) mm				Maximum
		Minimum insertion length				
		With one contact				
		d = ϕ 10	d = ϕ 12	d = ϕ 13	d = ϕ 16	
0~400	10	320	215	190	140	1000
0~500	10	320	215	190	140	
0~600	10	320	215	190	140	

- The above lengths are the minimum necessary of the bulb to be inserted into the fluid to be measured.
- Bulb length should be over the above length and specified in 5mm steps.
- For plain type, make the sum of 40mm added to the bulb minimum insertion dimension given in the table the minimum length.

The above minimum insertion length is the length without thermowell.
With thermowell, 25mm is added to the above length.

Thermometers with Micro Switch TF53·63

〈φ75 Indoor remote type〉

Liquid filled dial thermometer



Dimensions

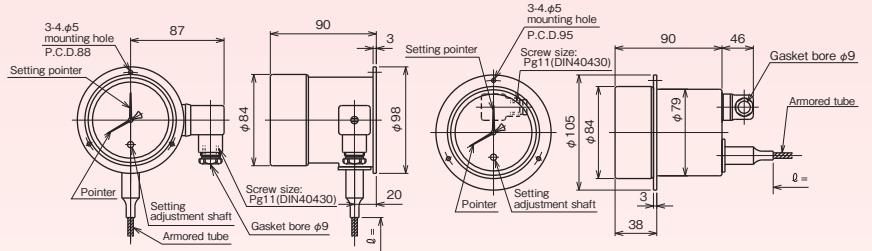

TF53 (Surface mounting)

TF63 (Panel mounting)

Model	Panel cut dimensions
TF63	φ81 ± 1

Specifications

Item	Description	
Manufacturing range	-70 to 50°C → 0 to 300°C	
Case	Construction: Indoor / Equivalent to IP42, Material: AC7A, Finish: Black	
Wetted parts material	Bulb: SUS304, Connection / Flange: SUS304	
Switch	Micro switch	Electric rating
Number of contacts	One contact (SPDT)	
Setting	Internal adjustment	
Lead length	1 · 2 · 3 · 4 · 5 · 8 · 10 (m)	Standard 3m
Compensation	Lead compensation	
Connection	R $\frac{1}{2}$, R $\frac{3}{4}$, $\frac{1}{2}$ NPT, G $\frac{1}{2}$ B, G $\frac{3}{4}$ B $\frac{1}{2}$ is not available with φ16 bulb and φ19, φ23 thermowell.	
Flange	JIS10K20ARF, JIS10K25ARF, ANSI1B15ORF, ANSI1B30ORF	
Connection	Without themowell	Union type, Slide type
	With themowell	Double socket union type: R $\frac{1}{2}$, $\frac{1}{2}$ NPT (Connection) Double socket slide type: R $\frac{1}{2}$, $\frac{1}{2}$ NPT (Connection)
Accuracy	Indication	Within ±2%F.S.
	Reproducibility	Within ±2%F.S.
	Setting	Within ±3%F.S.
Dead band	Within 8%F.S.	
Ambient temperature error	Within ±2%F.S. / 15°C	

● Other screws and flanges are manufactured. Please contact NKS for details.

Range / Bulb DIA. / Bulb length

Range °C	Minimum graduation °C	Bulb length (L) mm					Maximum
		Minimum insertion length					
		d = φ8	d = φ10	d = φ12	d = φ13	d = φ16	
-70~ 50	2	85	65	60	55	90	500
-70~100	5	75	60	55	75	75	
-50~ 50	2	95	70	60	55	55	
-30~ 50	2	105	75	65	60	55	
-20~100	2	85	65	60	55	90	
-10~100	2	90	70	60	55	90	
-10~ 50	1	125	85	75	65	60	
0~ 50	1	140	95	80	70	60	
~ 60	2	125	85	75	65	60	
~ 80	2	115	85	70	60	60	
~100	2	100	75	65	60	55	
~120	2	95	70	60	55	55	
~150	5	85	65	60	85	85	
~200	5	70	60	55	70	70	
~250	5	65	55	65	65	65	
~300	10	60	55	60	60	60	

- The above lengths are the minimum necessary of the bulb to be inserted into the fluid to be measured.
- Bulb length should be over the above length and specified in 5mm steps.
- For plain type, make the sum of 40mm added to the bulb minimum insertion dimension given in the table the minimum length.

The above minimum insertion length is the length without thermowell.
With thermowell, 25mm is added to the above length.

Thermometers with Micro Switch TF54·56

〈Surface mounting type〉

Liquid filled dial thermometer



Dimensions

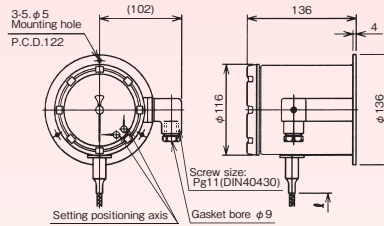

TF54 (φ 100)

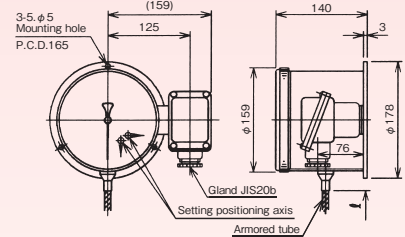

TF56 (φ 150)

Specifications

Item		Description	
Manufacturing range		-70 to 50°C → 0 to 300°C	
Case		Construction: Drip-proof / Equivalent to IP43, Material: TF54: AC7A, TF56: ADC12, Finish: Black	
Wetted parts material		Bulb: SUS304, Connection / Flange: SUS304	
Switch		Micro switch	
Number of contacts		One contact / Two contacts	
Setting		Internal adjustment	
Lead length		1 · 2 · 3 · 4 · 5 · 8 · 10 · 15 · 20 (m) Standard 3m Max. 20m (However, 15m for φ 100)	
Compensation		Lead compensation	
Connection		R $\frac{1}{2}$, R $\frac{3}{4}$, $\frac{1}{2}$ NPT, G $\frac{1}{2}$ B, G $\frac{3}{4}$ B $\frac{1}{2}$ is not available with φ 16 bulb and φ 19, φ 23 thermowell.	
Flange		JIS10K20ARF, JIS10K25ARF, ANSI1B150RF, ANSI1B300RF	
Connection	Without thermowell	Union type, Slide type	
	With thermowell	Double socket union type: R $\frac{1}{2}$, $\frac{1}{2}$ NPT (Connection) Double socket slide type: R $\frac{1}{2}$, $\frac{1}{2}$ NPT (Connection) Slide type is not available with φ 16 bulb.	
Accuracy	Indication	Within ±2%F.S.	
	Reproducibility	Within ±2%F.S.	
	Setting	Within ±3%F.S.	
Dead band		Within 4%F.S. (φ 100: within 6%F.S.)	
Ambient temperature error		Within ±2%F.S. /15°C	

- Other screws and flanges are manufactured. Please contact NKS for details.
- One contact is SPDT, φ 100 two contacts is SPST × 2, and φ 150 two contacts is SPDT × 2.
- TF56 is three contact type (one contact fixed), so is also available, please contact NKS.

Range / Bulb DIA. / Bulb length

Range °C	Minimum graduation °C	Bulb length (L) mm					Maximum
		Minimum insertion length					
		d = φ 8	d = φ 10	d = φ 12	d = φ 13	d = φ 16	
-70~ 50	2	160	110	90	75	65	500
-70~100	5	125	90	75	65	60	
-50~ 50	2	180	120	95	85	70	
-30~ 50	2	215	140	110	95	80	
-20~100	2	160	110	90	75	65	
-10~100	2	170	115	95	80	70	
-10~ 50	1	265	170	130	110	90	
0~ 50	1	305	190	145	125	100	
~ 60	1	265	170	130	110	90	
~ 80	2	245	155	120	105	85	
~100	2	205	135	105	90	75	
~120	2	180	120	95	85	70	
~150	2	155	105	85	75	65	
~200	5	110	80	70	60	55	
~250	5	100	75	65	60	55	
~300	5	90	70	60	55	50	

- The above lengths are the minimum necessary of the bulb to be inserted into the fluid to be measured.
- Bulb length should be over the above length and specified in 5mm steps.
- For plain type, make the sum of 40mm added to the bulb minimum insertion dimension given in the table the minimum length.

The above minimum insertion length is the length without thermowell.
With thermowell, 25mm is added to the above length.

Thermometers with Micro Switch TF64·66·74·76

〈Remote type〉

Liquid filled dial thermometer



Dimensions

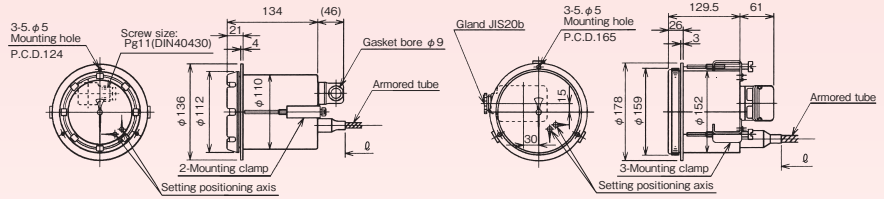

TF64 · 74

TF66 · 76

Model	Dial size	Panel cut dimension	Mounting
TF64	φ 100	φ 112±1	Mounting hole
TF74			Mounting clamp
TF66	φ 150	φ 154±1	Mounting hole
TF76			Mounting clamp

Specifications

Item		Description	
Manufacturing range		-70 to 50°C → 0 to 300°C	
Case		Construction: Drip-proof / Equivalent to IP43, Material: TF64 · 74: AC7A, TF66 · 76: ADC12, Finish: Black	
Wetted parts material		Bulb: SUS304, Connection / Flange: SUS304	
Switch		Micro switch	
Number of contacts		One contact / Two contacts	
Setting		Internal adjustment	
Lead length		1 · 2 · 3 · 4 · 5 · 8 · 10 · 15 · 20 (m) Standard 3m Max. 20m (However, 15m for φ 100)	
Compensation		Lead compensation	
Connection		R $\frac{1}{2}$, R $\frac{3}{4}$, $\frac{1}{2}$ NPT, G $\frac{1}{2}$ B, G $\frac{3}{4}$ B $\frac{1}{2}$ is not available with φ 16 bulb and φ 19, φ 23 thermowell.	
Flange		JIS10K20ARF, JIS10K25ARF, ANSI1B15ORF, ANSI1B30ORF	
Connection	Without thermowell	Union type, Slide type	
	With thermowell	Double socket union type: R $\frac{1}{2}$, $\frac{1}{2}$ NPT (Connection) Double socket slide type: R $\frac{1}{2}$, $\frac{1}{2}$ NPT (Connection)	
Accuracy	Indication	Within ±2%F.S.	
	Reproducibility	Within ±2%F.S.	
	Setting	Within ±3%F.S.	
Dead band		Within 4%F.S. (φ 100: within 6%F.S.)	
Ambient temperature error		Within ±2%F.S. / 15°C	

- Other screws and flanges are manufactured. Please contact NKS for details.
- One contact is SPDT, φ 100 two contacts is SPST × 2, and φ 150 two contacts is SPDT × 2.
- TF66 · 76 are three contact type (one contact fixed), so are also available, please contact NKS.

Range / Bulb DIA. / Bulb length

Range °C	Minimum graduation °C	Bulb length (L) mm					Maximum
		Minimum insertion length					
		d = φ 8	d = φ 10	d = φ 12	d = φ 13	d = φ 16	
-70~ 50	2	160	110	90	75	65	500
-70~ 100	5	125	90	75	65	60	
-50~ 50	2	180	120	95	85	70	
-30~ 50	2	215	140	110	95	80	
-20~ 100	2	160	110	90	75	65	
-10~ 100	2	170	115	95	80	70	
-10~ 50	1	265	170	130	110	90	
0~ 50	1	305	190	145	125	100	
~ 60	1	265	170	130	110	90	
~ 80	2	245	155	120	105	85	
~ 100	2	205	135	105	90	75	
~ 120	2	180	120	95	85	70	
~ 150	2	155	105	85	75	65	
~ 200	5	110	80	70	60	55	
~ 250	5	100	75	65	60	55	
~ 300	5	90	70	60	55	50	

- The above lengths are the minimum necessary of the bulb to be inserted into the fluid to be measured.
- Bulb length should be over the above length and specified in 5mm steps.
- For plain type, make the sum of 40mm added to the bulb minimum insertion dimension given in the table the minimum length.

The above minimum insertion length is the length without thermowell.
With thermowell, 25mm is added to the above length.

Thermometers with Micro Switch **TE54·56**

(Surface mounting type)

Gas filled dial thermometer

Corresponds to high temperature



Dimensions

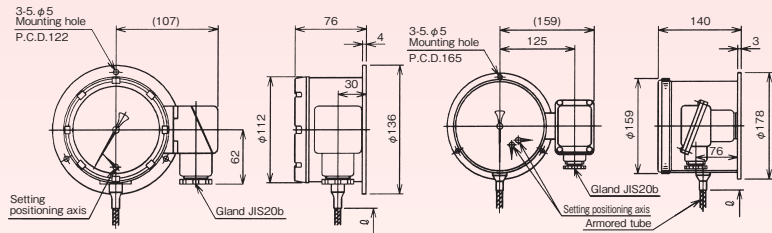

TE54 (φ 100)

TE56 (φ 150)

Specifications

Item		Description	
Manufacturing range		0 to 400°C, 0 to 500°C, 0 to 600°C	
Case		Construction: Drip-proof / Equivalent to IP43, Material: TE54: AC7A, TE56: ADC12, Finish: Black	
Wetted parts material		Bulb: SUS304, Connection / Flange: SUS304	
Switch		Micro switch	
Number of contacts		φ 100: One contact, φ 150: One contact (SPDT) / Two contacts (SPDT)	
Setting		Internal adjustment	
Lead length		1 · 2 · 3 · 4 · 5 · 8 · 10 (m) Standard 3m Max. 20m	
Compensation		Bimetal compensation (Indication only)	
Connection		R $\frac{1}{2}$, R $\frac{3}{4}$, $\frac{1}{2}$ NPT, G $\frac{1}{2}$ B, G $\frac{3}{4}$ B $\frac{1}{2}$ is not available with φ 16 bulb and φ 19, φ 23 thermowell.	
Flange		JIS10K20ARF, JIS10K25ARF, ANSI11B15ORF, ANSI11B30ORF	
Connection	Without thermowell	Union type, Slide type	Slide type is not available with φ 16 bulb. When the maximum temperature in the temperature range exceeds 400°C, slide type is not available.
	With thermowell	Double socket union type: R $\frac{1}{2}$, $\frac{1}{2}$ NPT (Connection) Double socket slide type: R $\frac{1}{2}$, $\frac{1}{2}$ NPT (Connection)	
Accuracy	Indication	Within ±2.5%F.S. (0 to 400°C), within ±2%F.S. (0 to 500°C, 0 to 600°C)	
	Reproducibility	Within ±2.5%F.S. (0 to 400°C), within ±2%F.S. (0 to 500°C, 0 to 600°C)	
	Setting	Within ±4.5%F.S. (0 to 400°C), within ±4%F.S. (0 to 500°C, 0 to 600°C)	
Dead band		Within 11%F.S. (0 to 400°C), within ±10%F.S. (0 to 500°C, 0 to 600°C)	
Ambient temperature error		Within ±2.5%F.S. / 15°C (0 to 400°C), within ±2%F.S. / 15°C (0 to 500°C, 0 to 600°C)	
Indication dial angle		250° (0 to 400°C), 270° (0 to 500°C, 0 to 600°C)	

●Other screws and flanges are manufactured. Please contact NKS for details.

Range / Bulb DIA. / Bulb length

Range °C	Minimum graduation °C	Bulb length (L) mm								Maximum
		Minimum insertion length								
		With one contact				With two contacts (φ 150 only is available.)				
		d = φ 10	d = φ 12	d = φ 13	d = φ 16	d = φ 10	d = φ 12	d = φ 13	d = φ 16	
0~400	10	320	215	190	140	—	290	245	180	1000
0~500	10	320	215	190	140	—	290	245	180	
0~600	10	320	215	190	140	—	290	245	180	

- The above lengths are the minimum necessary of the bulb to be inserted into the fluid to be measured.
- Bulb length should be over the above length and specified in 5mm steps.
- For plain type, make the sum of 40mm added to the bulb minimum insertion dimension given in the table the minimum length.

The above minimum insertion length is the length without thermowell.
With thermowell, 25mm is added to the above length.

Thermometers with Micro Switch TE64·66·74·76

Gas filled dial thermometer

<Remote type>

Corresponds to high temperature



Dimensions

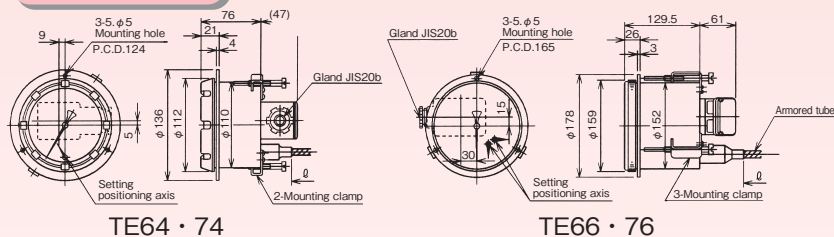

TE64 · 74

TE66 · 76

Model	Dial size	Panel cut dimension	Mounting
TE64	φ 100	φ 112±1	Mounting hole
TE74			Mounting clamp
TE66	φ 150	φ 154±1	Mounting hole
TE76			Mounting clamp

Specifications

Item		Description	
Manufacturing range		0 to 400°C, 0 to 500°C, 90 to 600°C	
Case		Construction: Drip-proof / Equivalent to IP43, Material: TF64 · 74: AC7A, TF66 · 76: ADC12, Finish: Black	
Wetted parts material		Bulb: SUS304, Connection / Flange: SUS304	
Switch		Micro switch	Electric rating
Number of contacts		φ 100: One contact, φ 150: One contact (SPDT) / Two contacts (SPDT)	Resistance load Inductive load*
Setting		Internal adjustment	125V AC 5A 125V AC 3A
Lead length		1 · 2 · 3 · 4 · 5 · 8 · 10 (m) Standard 3m Max. 20m	250V AC 5A 250V AC 3A
Compensation		Bimetal compensation (Indication only)	
Connection		R ¹ / ₂ , R ³ / ₄ , 1/2 NPT, G ¹ / ₂ B, G ³ / ₄ B 1/2 is not available with φ 16 bulb and φ 19, φ 23 thermowell.	30V DC 5A 30V DC 3A
Flange		JIS10K20ARF, JIS10K25ARF, ANSI11B150RF, ANSI11B300RF	
Connection	Without thermowell	Union type, Slide type	Slide type is not available with φ 16 bulb. When the maximum temperature in the temperature range exceeds 400°C, slide type is not available.
	With thermowell	Double socket union type: R ¹ / ₂ , 1/2 NPT (Connection) Double socket slide type: R ¹ / ₂ , 1/2 NPT (Connection)	
Accuracy	Indication	Within ±2.5%F.S. (0 to 400°C), within ±2%F.S. (0 to 500°C, 0 to 600°C)	
	Reproducibility	Within ±2.5%F.S. (0 to 400°C), within ±2%F.S. (0 to 500°C, 0 to 600°C)	
	Setting	Within ±4.5%F.S. (0 to 400°C), within ±4%F.S. (0 to 500°C, 0 to 600°C)	
Dead band		Within 11%F.S. (0 to 400°C), within ±10%F.S. (0 to 500°C, 0 to 600°C)	
Ambient temperature error		Within ±2.5%F.S. /15°C (0 to 400°C), within ±2%F.S. /15°C (0 to 500°C, 0 to 600°C)	
Indication dial angle		250° (0 to 400°C), 270° (0 to 500°C, 0 to 600°C)	

●Other screws and flanges are manufactured. Please contact NKS for details.

Range / Bulb DIA. / Bulb length

Range °C	Minimum graduation °C	Bulb length (L) mm								Maximum
		Minimum insertion length								
		With one contact				With two contacts (φ 150 only is available.)				
		d = φ 10	d = φ 12	d = φ 13	d = φ 16	d = φ 10	d = φ 12	d = φ 13	d = φ 16	
0~400	10	320	215	190	140	—	290	245	180	1000
0~500	10	320	215	190	140	—	290	245	180	
0~600	10	320	215	190	140	—	290	245	180	

- The above lengths are the minimum necessary of the bulb to be inserted into the fluid to be measured.
- Bulb length should be over the above length and specified in 5mm steps.
- For plain type, make the sum of 40mm added to the bulb minimum insertion dimension given in the table the minimum length.

The above minimum insertion length is the length without thermowell.
With thermowell, 25mm is added to the above length.

TF1·5·6·7

Thermometers with Electric Contact

Model number configuration

Please specify the model number, each specs and the range for ordering.

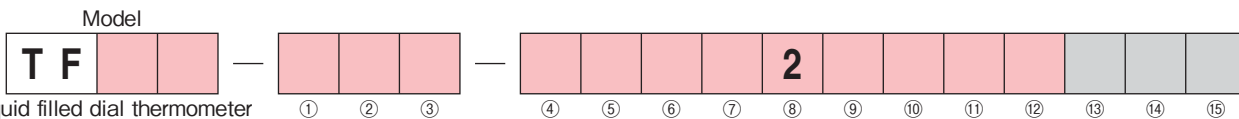

Liquid filled dial thermometer with micro switch

Model number		Selective spec.		Additional spec. (Option)
Type	1	Direct type / 1 stem type φ 75 and φ 150 not available.		
	5	Remote type / surface mounting type		
	6	Remote type / mounting type (Hole mounting)		
	7	Remote type / mounting type (Clamp mounting) φ 75 not available.		
Size	3	φ 75 Direct type not available		
	4	φ 100		
	6	φ 150 Direct type not available		

① Thermowell inside screws For with thermowell, please specify the thermowell type on a separate page.	0	Without thermowell		
		With thermowell		Welded type
			Drilled type	Welded type
			Straight	Taper
			Flange	
		1	Inside screws: Standard (W22 thread14) and for slide type	
	2	Inside screws: Rc1/2 double socket		SW12 SW42 SW71(SW70) SW81
	3	Inside screws: 1/2NPT double socket		SW13 SW43 SW72 SW82
	4	Inside screws: G1/2 double socket		SW14 SW44 SW73 —
	5	Inside screws: Rc3/4 double socket		SW15 SW45 SW74 —

② Connecting part	0	Union type		
	1	Slide type (Not available for 1 stem type and φ 16 bulb and when maximum temperature of temperature range exceeds 400°C.)		
	4	Plain type		

③ Connecting screws	0	R1/2	H	JIS10K50ARF
	1	R3/4	J	JIS20K20ARF
	2	1/2NPT	K	JIS20K25ARF
	3	G1/2B	L	JIS10K15AFF
	4	G3/4B	M	JIS10K20AFF
	5	JIS10K20ARF	N	JIS10K25AFF
	6	JIS10K25ARF	P	ANSI3/4B15ORF
	7	ANSI1B15ORF	Q	ANSI3/4B30ORF
	8	ANSI1B30ORF	R	ANSI1B60ORF
	A	Fixing screws (W22 thread 14) union type only	S	ANSI 1 1/2B15ORF
	B	R3/8	T	ANSI 1 1/2B30ORF
	C	R1	U	ANSI 1 1/2B60ORF
	D	3/4NPT	W	JPI 1B15ORF
	E	1NPT	X	JPI 1B30ORF
	F	JIS10K15ARF	Y	JPI 1B60ORF
G	JIS10K40ARF	Z	Plain type	

Please specify the temperature range and units separately besides selection of range code.

④ Range °C	1	0 to 50, 60, 80, 100, 120, 150
	2	0 to 200, 250, 300
	5	-10 to 50, -30 to 50, -50 to 50, -10 to 100
	6	-70 to 50, -20 to 100, -70 to 100

⑤ Bulb material	1	SUS304
	2	SUS316
	X	With thermowell

⑥ Bulb DIA.	1	d=φ 8	Direct type for slide type not available
	2	d=φ 10	Direct type for slide type not available
	3	d=φ 12	Direct type for slide type not available
	4	d=φ 13	Direct type for slide type not available
	5	d=φ 16	Slide type not available
	X	With thermowell	

⑦ Bulb length	A	Minimum dimension to 500m
	X	With thermowell

⑧ Compensation	2	Lead compensation
----------------	---	-------------------

⑨ Lead type	0	Direct type
	2	Armored tube B (SUS430) (Standard)
	B	Armored tube B (SUS304)
	E	Armored tube B (SUS316)

⑩ Lead length	0	Direct type
	ア	Up to 3m
	イ	Up to 4m
	ウ	Up to 5m
	エ	Up to 6m
	オ	Up to 7m
	カ	Up to 8m
	キ	Up to 9m
	ク	Up to 10m
	9	Other specifications (/m)

⑪ Contact	A	H: Upper limit type with 1 contact
	B	L: Lower limit type with 1 contact
	C	HL: Upper & lower limit type with 2 contacts φ 75 not available
		Other specifications

⑫ Electric wire outlet	7	Gland JIS20b φ 150: Standard (φ 75 and φ 100: not available)
	B	Conduit type G1/2 (φ 75 and φ 100: not available)
	C	Conduit type G3/4 (φ 75 and φ 100: not available)
	0	φ 75 and φ 100: DIN φ 9

⑬ Kind of thermowell	1	Welded type	
	4	Drilled type straight	
	7	Drilled type taper	
	8	Welded flange	
⑭ Thermowell inside screws	0	For slide type. General products: Not available	
	1	W22 thread 14	
	2	Rc1/2	
	3	1/2NPT	
	4	G1/2	
		General products: Not available	
	5	Rc3/4	

- [Manufacturing range]**
- Two contacts of φ 75 is not available.
 - Thermowell inside screws: For slide type, 1 stem type and φ 16 bulb are not available.
 - TF56·66·76 are three contact type (one contact fixed), so are also available, please contact NKS.

* When ordering, please specify the bulb length and lead length.
* The thermowell model composition is SW ⑬⑭.
* For with thermowell, please refer to P 1⑬ to thermowell manufacturing specifications and specify the SW model also.

*Specify "X" if there is no specification item.

⑮ Documents	0	Nil
	1	Required (Please specify the desired documents separately.) Submission drawings, instruction manual, inspection procedure, mill sheet, test report (1 pc 1 copy), traceability / inspection certificate, strength calculation, attended inspection

TE1·5·6·7

Thermometers with Electric Contact

Model number configuration

Please specify the model number, each specs and the range for ordering.

Model

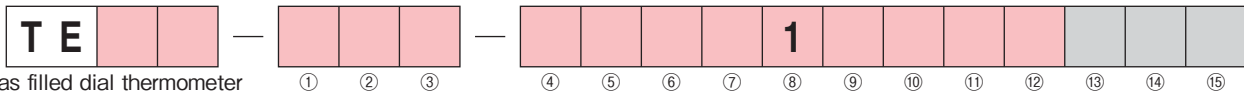

Model number		Selective spec.				Additional spec. (Option)								
Type	1	Direct type / I stem type 150DIA. not available.												
	5	Remote type / surface mounting type												
	6	Remote type / mounting type (Hole mounting)												
	7	Remote type / mounting type (Clamp mounting)												

Size	4	φ 100												
	6	φ 150 Direct type not available												

① Thermowell inside screws For with thermowell, please specify the thermowell type on a separate page.	0	Without thermowell						
		With thermowell			Welded type	Drilled type		Welded type
	1	Inside screws: Standard (W22 thread14) and for slide type			SW11(SW10)	SW41(SW40)	SW71(SW70)	SW81
	2	Inside screws: Rc1/2 double socket			SW12	SW42	SW72	SW82
	3	Inside screws: 1/2NPT double socket			SW13	SW43	SW73	---
	4	Inside screws: G1/2 double socket			SW14	SW44	SW74	---
5	Inside screws: Rc3/4 double socket			SW15	SW45	SW75	---	

② Connecting part	0	Union type			
	1	Slide type (Not available for I stem type and φ 16 bulb and when maximum temperature of temperature range exceeds 400°C.)			
	4	Plain type			

③ Connecting screws	0	R1/2	H	JIS10K50ARF
	1	R3/4	J	JIS20K20ARF
	2	1/2NPT	K	JIS20K25ARF
	3	G1/2B	L	JIS10K15AFF
	4	G3/4B	M	JIS10K20AFF
	5	JIS10K20ARF	N	JIS10K25AFF
	6	JIS10K25ARF	P	ANSI3/4B15ORF
	7	ANSI1B15ORF	Q	ANSI3/4B30ORF
	8	ANSI1B30ORF	R	ANSI1B60ORF
	A	Fixing screws (W22 thread 14) union type only	S	ANSI 1 1/2B15ORF
	B	R3/8	T	ANSI 1 1/2B30ORF
	C	R1	U	ANSI 1 1/2B60ORF
	D	3/4NPT	W	JPI 1B15ORF
	E	1NPT	X	JPI 1B30ORF
	F	JIS10K15ARF	Y	JPI 1B60ORF
	G	JIS10K40ARF	Z	Plain type

④ Range °C	3	0 to 400, 500	
	4	0 to 600	

Please specify the temperature range and units separately besides selection of range code.

⑤ Bulb material	1	SUS304	
	2	SUS316	
	X	With thermowell	

⑥ Bulb DIA.	2	d=φ 10	Direct type for slide type not available	2 contacts not available
	3	d=φ 12	Direct type for slide type not available	
	4	d=φ 13	Direct type for slide type not available	
	5	d=φ 16	Slide type not available	
	X	With thermowell		

⑦ Bulb length	A	Minimum dimension to 500mm		
	B	505 to 600mm		
	C	605 to 700mm		
	D	705 to 800mm		
	E	805 to 900mm		
	F	905 to 1000mm		
	X	With thermowell		

⑧ Compensation	1	Bimetal compensation (Indication only)	
----------------	---	--	--

⑨ Lead type	0	Direct type	
	2	Armored tube B (SUS430) (Standard)	
	B	Armored tube B (SUS304)	
	E	Armored tube B (SUS316)	

⑩ Lead length	0	Direct type	
	A	Up to 3m	
	B	Up to 4m	
	C	Up to 5m	
	D	Up to 6m	
	E	Up to 7m	
	F	Up to 8m	
	G	Up to 9m	
	H	Up to 10m	
	9	Other specifications (/m)	

⑪ Contact	A	H: Upper limit type with 1 contact	
	B	L: Lower limit type with 1 contact	
	C	HL: Upper & lower limit type with 2 contacts φ 100 not available	
		Other specifications	

⑫ Electric wire outlet	7	Gland JIS20b (Standard)	
	B	Conduit type G1/2	
	C	Conduit type G3/4	

⑬ Kind of thermowell	1	Welded type	
	4	Drilled type straight	
	7	Drilled type taper	
	8	Welded flange	
⑭ Thermowell inside screws	0	For slide type. General products: Not available	
	1	W22 thread 14	
	2	Rc1/2	
	3	1/2NPT	
	4	G1/2	
		General products: Not available	
5	Rc3/4		

- [Manufacturing range]
 • Two contacts of φ 100 is not available.
 • Thermowell inside screws: For slide type, not available for I stem type and φ 16 bulb and when maximum temperature of temperature range exceeds 400°C.
 * When ordering, please specify the bulb length and lead length.
 * The thermowell model composition is SW 13⑬⑭.
 * For with thermowell, please refer to P 16 to thermowell manufacturing specifications and specify the SW model also.

*Specify "X" if there is no specification item.

⑮ Documents	0	Nil	
	1	Required (Please specify the desired documents separately.) Submission drawings, instruction manual, inspection procedure, mill sheet, test report (1 pc 1 copy), traceability / inspection certificate, strength calculation, attended inspection	

Explosion-proof Thermometer with Micro Switch

TD25

Liquid filled dial thermometer

〈Surface mounting type〉

Dimensions

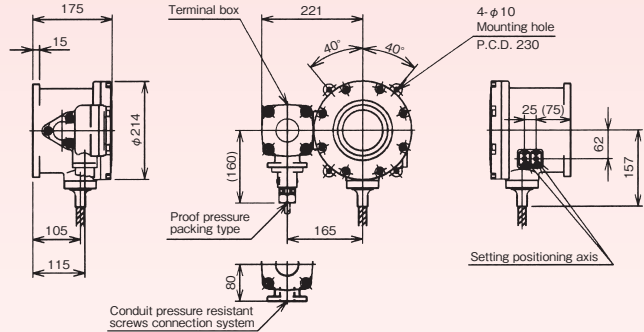
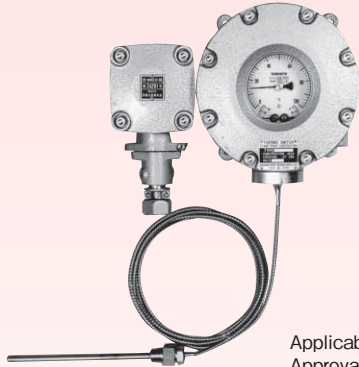

Applicable model: d2G4
Approval number for labor ministry inspection: No. T24201
Weight: Approx. 12kg (Indicator part)

Specifications

Item	Description	
Manufacturing range	-70 to 50°C → 0 to 300°C	
Indication dial	Local indicator	
Switch	Micro switch	
Number of contacts	One contact (SPDT) / Two contacts (SPDT)	Electric rating
Setting	External adjustment	
Lead length	1 · 2 · 3 · 4 · 5 · 8 · 10 · 15 · 20 (m) Standard 3m Max. 20m	Resistance load 125V AC 5A 250V AC 5A 30V DC 5A 125V DC 0.4A
Case	Construction: Drip-proof / Equivalent to IP54, Material: AC7A, Finish: Grey crystal	
Wetted parts material	Bulb: SUS304, Connection / Flange: SUS304	
Compensation	Lead compensation	
Connection	R $\frac{1}{2}$, R $\frac{3}{4}$, $\frac{1}{2}$ NPT, G $\frac{1}{2}$ B, G $\frac{3}{4}$ B $\frac{1}{2}$ is not available with ϕ 16 bulb and ϕ 19, ϕ 23 thermowell.	
Flange	JIS10K20ARF, JIS10K25ARF, ANSI11B150RF, ANSI11B300RF	
Connection	Without thermowell	Union type, Slide type
	With thermowell	Double socket union type: R $\frac{1}{2}$, $\frac{1}{2}$ NPT (Connection) Double socket slide type: R $\frac{1}{2}$, $\frac{1}{2}$ NPT (Connection)
Accuracy	Indication	Within $\pm 2\%$ F.S.
	Reproducibility	Within $\pm 2\%$ F.S.
	Setting	Within $\pm 3\%$ F.S.
Dead band	Within 4%F.S.	
Ambient temperature error	Within $\pm 2\%$ F.S. / 15°C	

Range / Bulb DIA. / Bulb length

Range °C	Minimum graduation °C	Bulb length (L) mm					Maximum
		Minimum insertion length					
		d = ϕ 8	d = ϕ 10	d = ϕ 12	d = ϕ 13	d = ϕ 16	
-70~ 50	2	160	110	90	75	65	500
-70~100	5	125	90	75	65	60	
-50~ 50	2	180	120	95	85	70	
-30~ 50	2	215	140	110	95	80	
-20~100	2	160	110	90	75	65	
-10~100	2	170	115	95	80	70	
-10~ 50	1	265	170	130	110	90	
0~ 50	1	305	190	145	125	100	
~ 60	1	265	170	130	110	90	
~ 80	2	245	155	120	105	85	
~100	2	205	135	105	90	75	
~120	2	180	120	95	85	70	
~150	2	155	105	85	75	65	
~200	5	110	80	70	60	55	
~250	5	100	75	65	60	55	
~300	5	90	70	60	55	50	

- The above lengths are the minimum necessary of the bulb to be inserted into the fluid to be measured.
- Bulb length should be over the above length and specified in 5mm steps.
- For plain type, make the sum of 40mm added to the bulb minimum insertion dimension given in the table the minimum length.

The above minimum insertion length is the length without thermowell.
With thermowell, 25mm is added to the above length.

Explosion-proof Thermometer with Micro Switch

(Surface mounting type)

TD21

Gas filled dial thermometer

Corresponds to high temperature

Dimensions

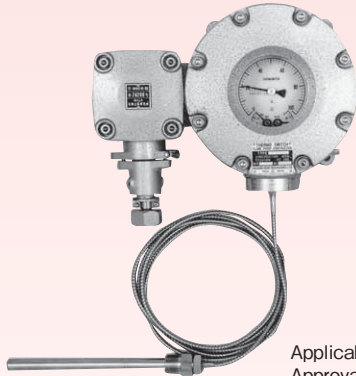

Applicable model: d2G4
Approval number for labor ministry inspection: No. T24200
Weight: Approx. 11.5kg (Indicator part)

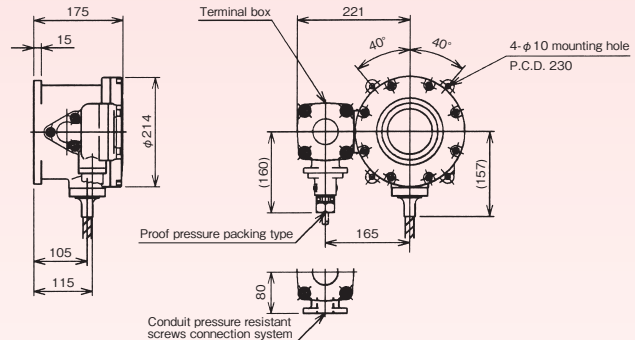

Specifications

Item	Description	
Manufacturing range	0 to 400°C, 0 to 500°C, 0 to 600°C	
Indication dial	Local indicator	
Switch	Micro switch	
Number of contacts	One contact (SPDT) / Two contacts (SPDT)	Electric rating
Setting	Internal adjustment	
Lead length	1 · 2 · 3 · 4 · 5 · 8 · 10 (m) Standard 3m Max. 20m	Resistance load 125V AC 5A 250V AC 5A 30V DC 5A 125V DC 0.4A
Case	Construction: Drip-proof / Equivalent to IP54, Material: AC7A, Finish: Grey crystal	Inductive load* 125V AC 3A 250V AC 3A 30V DC 3A 125V DC 0.4A
Wetted parts material	Bulb: SUS304, Connection / Flange: SUS304	* AC: Power factor 0.4 or more DC: Time-contact 7ms or less
Compensation	Bimetal compensation (Indication only)	
Connection	R $\frac{1}{2}$, R $\frac{3}{4}$, $\frac{1}{2}$ NPT, G $\frac{1}{2}$ B, G $\frac{3}{4}$ B $\frac{1}{2}$ is not available with ϕ 16 bulb and ϕ 19, ϕ 23 thermowell.	
Flange	JIS10K20ARF, JIS10K25ARF, ANSI1B150RF, ANSI1B300RF	
Connection	Without thermowell	Union type, Slide type
	With thermowell	Double socket union type: R $\frac{1}{2}$, $\frac{1}{2}$ NPT (Connection) Double socket slide type: R $\frac{1}{2}$, $\frac{1}{2}$ NPT (Connection)
		Slide type is not available with ϕ 16 bulb. When the maximum temperature in the temperature range exceeds 400°C, slide type is not available.
Accuracy	Indication	Within $\pm 2.5\%$ F.S. (0 to 400°C), within $\pm 2\%$ F.S. (0 to 500°C, 0 to 600°C)
	Reproducibility	Within $\pm 2.5\%$ F.S. (0 to 400°C), within $\pm 2\%$ F.S. (0 to 500°C, 0 to 600°C)
	Setting	Within $\pm 4.5\%$ F.S. (0 to 400°C), within $\pm 4\%$ F.S. (0 to 500°C, 0 to 600°C)
Dead band	Within 11%F.S. (0 to 400°C), within $\pm 10\%$ F.S. (0 to 500°C, 0 to 600°C)	
Ambient temperature error	Within $\pm 2.5\%$ F.S. / 15°C (0 to 400°C), within $\pm 2\%$ F.S. / 15°C (0 to 500°C, 0 to 600°C)	
Indication dial angle	250° (0 to 400°C), 270° (0 to 500°C, 0 to 600°C)	

●Other screws and flanges are manufactured. Please contact NKS for details.

Range / Bulb DIA. / Bulb length

Range °C	Minimum graduation °C	Bulb length (L) mm								Maximum
		Minimum insertion length								
		With one contact				With two contacts (ϕ 150 only is available.)				
		d = ϕ 10	d = ϕ 12	d = ϕ 13	d = ϕ 16	d = ϕ 10	d = ϕ 12	d = ϕ 13	d = ϕ 16	
0~400	10	320	215	190	140	—	290	245	180	1000
0~500	10	320	215	190	140	—	290	245	180	
0~600	10	320	215	190	140	—	290	245	180	

- The above lengths are the minimum necessary of the bulb to be inserted into the fluid to be measured.
- Bulb length should be over the above length and specified in 5mm steps.
- For plain type, make the sum of 40mm added to the bulb minimum insertion dimension given in the table the minimum length.

The above minimum insertion length is the length without thermowell.
With thermowell, 25mm is added to the above length.

Explosion-proof

Explosion-proof construction

Explosion-proof construction is a totally enclosed construction such that even if the explosive gas explodes inside the container, the container withstands the force of the explosion and there is no danger of ignition of external explosive gases.

Application range: d2G4

- 1) Explosion-proof construction: d
- 2) Explosion class : 2
- 3) Ignitability : G 4
- 4) Hazardous areas : Zone 1 or zone 2
- 5) Objective industries : Petrochemical, chemical fiber, synthetic resin, ethylene, methanol, dielectric products manufacturing, liquefied gas, electric furnace, pharmaceuticals, paints, ammonium sulfate, soda, other measurement medium or industries in which there is the danger of ignition and explosion.

Classification of hazardous areas:

Hazardous area	Contents
Zone 0	A place where hazardous atmosphere is continuously present or present for a long period under ordinary circumstances.
Zone 1	A place where hazardous atmosphere is likely to occur under ordinary circumstances.
Zone 2	A place where hazardous atmosphere is likely to occur under abnormal circumstances.

Classification of explosion:

Explosion class	Minimum gap with a 25mm length of path which permits the flame propagation
1	Over 0.6mm
2	0.4mm to 0.6mm
3	Up to 0.4mm

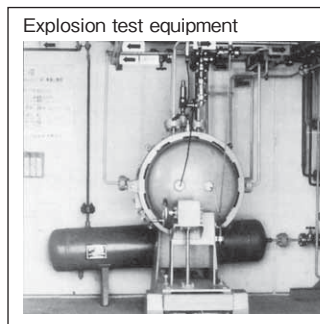

Classification of ignition groups:

Ignition class	Ignition point	Limits of temperature rise (deg)
G 1	Over 450°C	320
G 2	300°C to 450°C	200
G 3	200°C to 300°C	120
G 4	135°C to 200°C	70
G 5	100°C to 135°C	40
G 6	85°C to 100°C	30

The standard ambient temperature range of an electric instrument in the normal usage state shall be 40°C.

Example of classification of typical explosive gases:

Explosion class	Ignition class	G 1	G 2	G 3	G 4	G 5	G 6
		Acetone	Ethanol	Gasoline	Acetaldehyde		
1	Ammonia	Isopentyl acetat	Hexane	Ethyl ether			
	Carbon monoxide	1-Butanol					
	Ethane	Butane					
	Acetic acid	Acetic anhydride					
	Ethyl acetate						
	Toluene						
	Propane						
	Benzene						
	Methanol						
	Methane						
2	Carbon gas	Ethylene					
		Ethylene oxide					
3	Water gas	Acetylene				Carbon dioxide	
	Hydrogen						

Explosion-proof

Method of leading in of external conductors and cable to a terminal box

Leading in of external conductors and cable to a terminal box uses a pressure resistant gasket method and a conduit method.

1) Flame-proof gasket type

For rubber, plastic tube, etc. lead in.

Gasket inner dia. (d)	Cable outer dia. (d)	Cable protection tube connection
10.5	9.4	PF 1/2 PF 3/4
	9.9	
	10.1	
12	10.5	PF 3/4 PF 1
	11.0	
	11.5	
14	11.9	PF 3/4 PF 1
	12.0	
	12.5	
	12.6	
15.5	13.1	PF 3/4 PF 1
	13.5	
	13.6	
	14.5	
16.5	15.6	

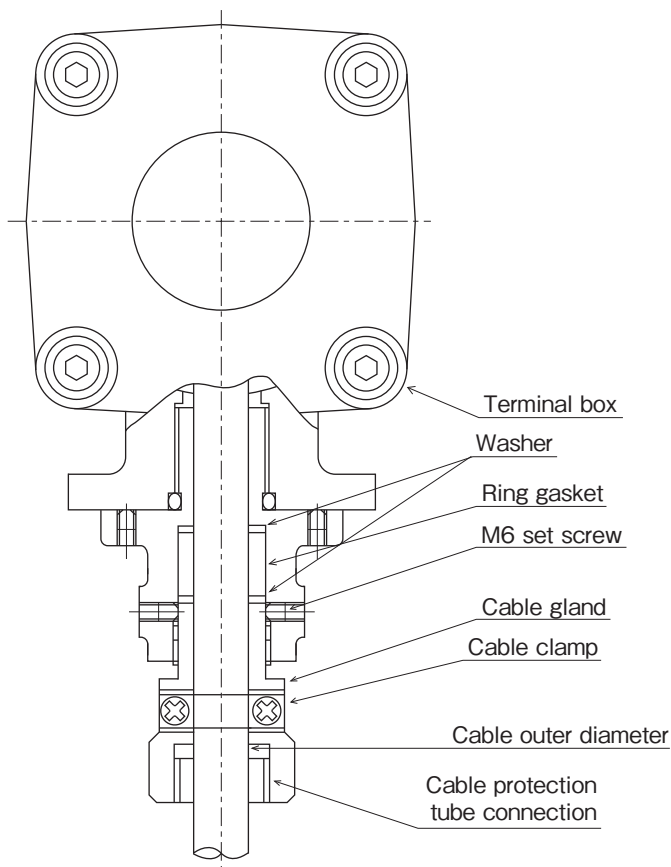

2) Conduit pressure resistant screw connection system conduit

For leading in of conduit.

When metal conduit wiring is performed, sealing like that shown below must be performed near the terminal box and the conduit connection.

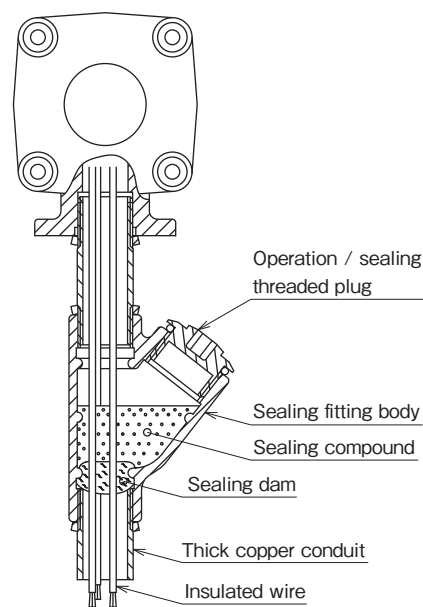
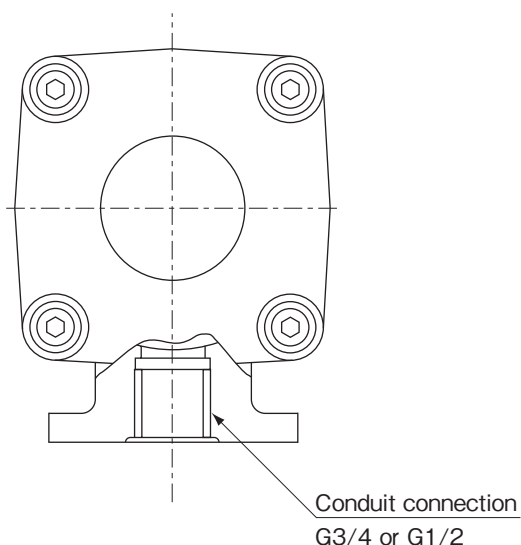

Note) Use the 600V vinyl insulated electric wire specified by JIS C 3307 or better as the metal conduit electric wire. Do not use cable of cabtyre cable.

TD21·25

Thermometers with Electric Contact

Model number configuration

Please specify the model number, each specs and the range for ordering.

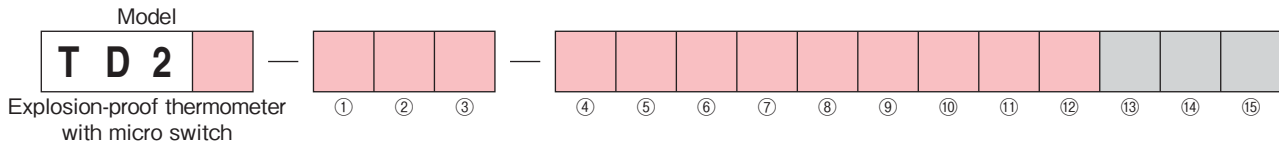

Model number		Selective spec.				Additional spec. (Option)	
Type	1 5	Gas filled type Liquid filled type	Surface mounting type: with micro switch	Bimetal compensation Lead compensation	AC7A, Grey crystal AC7A, Grey crystal		

① Thermowell inside screws For with thermowell, please specify the thermowell type on a separate page.	0	Without thermowell	Welded type	Drilled type		Welded type
		With thermowell		Straight	Taper	Flange
	1	Inside screws: Standard (W22 thread 14)	SW11(SW10)	SW41(SW40)	SW71(SW70)	SW81
	2	Inside screws: Rc1/2 double socket	SW12	SW42	SW72	SW82
	3	Inside screws: 1/2NPT double socket	SW13	SW43	SW73	—
	4	Inside screws: G1/2 double socket	SW14	SW44	SW74	—
	5	Inside screws: Rc3/4 double socket	SW15	SW45	SW75	—

② Connecting part	0	Union type
	1	Slide type (Not available for ϕ 16 bulb, and when the maximum temperature of temperature range exceeds 400°C.)
	4	Plain type

③ Connecting screws	0	R1/2	H	JIS10K50ARF
	1	R3/4	J	JIS20K20ARF
	2	1/2NPT	K	JIS20K25ARF
	3	G1/2B	L	JIS10K15AFF
	4	G3/4B	M	JIS10K20AFF
	5	JIS10K20ARF	N	JIS10K25AFF
	6	JIS10K25ARF	P	ANSI3/4B150RF
	7	ANSI1B150RF	Q	ANSI3/4B300RF
	8	ANSI1B300RF	R	ANSI1B600RF
	A	Fixing screws (W22 thread 14)	S	ANSI 1 1/2B150RF
	B	R3/8	T	ANSI 1 1/2B300RF
	C	R1	U	ANSI 1 1/2B600RF
	D	3/4NPT	W	JPI 1B150RF
	E	1NPT	X	JPI 1B300RF
	F	JIS10K15ARF	Y	JPI 1B600RF
	G	JIS10K40ARF	Z	Plain type

Please specify the temperature range and units separately besides selection of range code.

④ Range °C	1	0 to 50, 60, 80, 100, 120, 150	TD25 only
	2	0 to 200, 250, 300	TD25 only
	3	0 to 400, 500	TD21 only
	4	0 to 600	TD21 only
	5	-10 to 50, -30 to 50, -50 to 50	TD25 only
	6	-70 to 50, -70 to 100, -20 to 100, -10 to 100	TD25 only

⑤ Bulb material	1	SUS304
	2	SUS316
	X	With thermowell

⑥ Bulb DIA.	1	d=φ8
	2	d=φ10
	3	d=φ12
	4	d=φ13
	5	d=φ16
	X	With thermowell

⑦ Bulb length	A	Minimum dimension to 500mm
	B	505 to 600mm
	C	605 to 700mm
	D	705 to 800mm
	E	805 to 900mm
	F	905 to 1000mm
		Other specified (/100mm)
	X	With thermowell

⑧ Compensation	1	Bimetal compensation	TD21
	2	Lead compensation	TD25

⑨ Lead type	2	Armored tube B (SUS430) (Standard)
	B	Armored tube B (SUS304)
	E	Armored tube B (SUS316)

⑩ Lead length	Bimeta		Lead
	A	ア	Up to 3m
	B	イ	Up to 4m
	C	ウ	Up to 5m
	D	エ	Up to 6m
	E	オ	Up to 7m
	F	カ	Up to 8m
	G	キ	Up to 9m
	H	ク	Up to 10m
	9	9	Other specifications (/m)

⑪ Contact	A	H: Upper limit type with 1 contact
	B	L: Lower limit type with 1 contact
	C	HL: Upper & lower limit type with 2 contacts

⑫ Electric wire outlet	C	Conduit type G3/4 (Standard)
	カ	Proof pressure packing type, G1/2×12
	キ	Proof pressure packing type, G3/4×10.5
	コ	Proof pressure packing type, G3/4×14

⑬ Kind of thermowell	1	Welded type
	4	Drilled type straight
	7	Drilled type taper
	8	Welded flange
⑭ Thermowell inside screws	0	For slide type. General products: Not available
	1	W22 thread 14
	2	Rc1/2
	3	1/2NPT
	4	G1/2
5	Rc3/4	General products: Not available

[Manufacturing range]

• Thermowell inside screws: For slide type, not available for ϕ 16 bulb and when maximum temperature of temperature range exceeds 400°C.

* When ordering, please specify the bulb length and lead length.

* The thermowell model composition is SW (⑬)(⑭).

* For with thermowell, please refer to P 16 to thermowell manufacturing specifications and specify the SW model also.

*Specify "X" if there is no specification item.

⑮ Documents	0	Nil
	1	Required (Please specify the desired documents separately.) Submission drawings, instruction manual, inspection procedure, mill sheet, test report (1 pc 1 copy), traceability / inspection certificate, strength calculation, attended inspection

Thermometers with Contact Switch

(Indoor • Surface mounting type)

TK53•54•56

Liquid / Gas filled dial thermometer



Dimensions

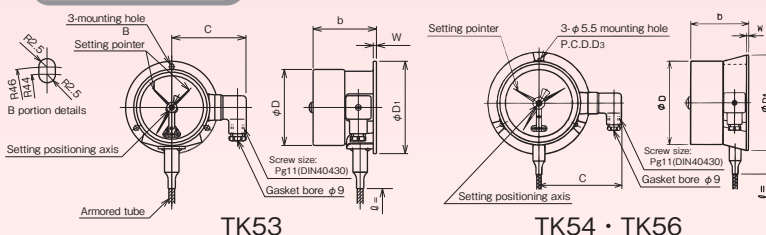

Model	Dial size	Dimensions					
		D	D ₁	D ₃	b	W	C
TK53	75	84	102	—	70	3.5	(87)
TK54	100	112	128	115	78	3	(111)
TK56	150	165	178	165	85	4	(137)

Specifications

Item	Description		
Manufacturing range	-70 to 50°C → 0 to 650°C		
Case	Construction: Indoor / Equivalent to IP32, Material: TK53 • 54: ADC12, TK53: AC7A, Finish: Black		
Wetted parts material	Bulb: SUS304, Connection / Flange: SUS304		
Switch used	Contact switch (Open low contact pressure)		
Number of contacts	One contact / Two contacts		
Setting	External adjustment		
Lead length	1 • 2 • 3 • 4 • 5 • 8 • 10 • 15 • 20 (m) Standard 3m Max.: Bimetal compensation 5m (400°C or more: 20m) Lead compensation 20m (φ 75, φ 100: Not available)		
Compensation	TK53, TK54 Bimetal compensation TK56 Bimetal compensation, lead compensation (For 400°C or more, bimetal compensation only)		
Connection	R ¹ / ₂ , R ³ / ₄ , 1/2NPT, G ¹ / ₂ B, G ³ / ₄ B 1/2 is not available with φ 16 bulb and φ 19, φ 23 thermowell.		
Flange	JIS10K20ARF, JIS10K25ARF, ANSI1B150RF, ANSI1B300RF		
Connection	Without thermowell	Union type, Slide type	Slide type is not available with φ 16 bulb. When the maximum temperature of temperature range exceeds 400°C, slide type is not available.
	With thermowell	Double socket union type: R ¹ / ₂ , 1/2NPT (Connection) Double socket slide type: R ¹ / ₂ , 1/2NPT (Connection)	
Accuracy	Indication	Within ±2%F.S. *Accuracy when 1 contact is free.	
	Reproducibility	Within ±2%F.S.	
	Setting	Within ±3%F.S.	
Dead band	Within 4%F.S.		
Ambient temperature error	Within ±2%F.S. / 15°C		

Range / Bulb DIA. / Bulb length

Range °C	Minimum graduation °C	Bulb minimum insertion length mm										Bulb maximum length mm		
		Bimetal compensation					φ 150 lead compensation							
		Bulb outer diameter					Lead length							
		φ8	φ10	φ12	φ13	φ16	Lead length	φ8	φ10	φ12	φ13	φ16	Lead length	
-70 ~ 50	2	50	45	40	40	50	~ 5m	50	45	40	40	50	~ 20m	500
-70 ~ 100	5	40	40	40	40	40	~ 5m	40	40	40	40	40	~ 20m	
-50 ~ 50	2	55	45	40	40	55	~ 5m	55	45	40	40	55	~ 20m	
-30 ~ 50	2	65	55	45	40	40	~ 5m	65	55	45	40	40	~ 20m	
-20 ~ 100	2	50	45	40	40	50	~ 5m	50	45	40	40	50	~ 20m	
-10 ~ 50	1	70	60	50	45	40	~ 5m	70	60	50	45	40	~ 20m	
0 ~ 50	1	70	60	50	45	40	~ 5m	70	60	50	45	40	~ 20m	
~ 60	1	65	55	45	40	40	~ 5m	65	55	45	40	40	~ 20m	
~ 80	2	65	55	45	40	40	~ 5m	65	55	45	40	40	~ 20m	
~ 100	2	55	45	40	40	55	~ 5m	55	45	40	40	55	~ 20m	
~ 120	2	50	45	40	40	50	~ 5m	50	45	40	40	50	~ 20m	
~ 150	2	40	40	40	40	40	~ 5m	40	40	40	40	40	~ 20m	
~ 200	5	40	40	40	40	40	~ 5m	40	40	40	40	40	~ 20m	
~ 250	5	40	40	40	40	40	~ 5m	40	40	40	40	40	~ 20m	
~ 300	5	40	40	40	40	40	~ 5m	40	40	40	40	40	~ 20m	
~ 400	10	230	170	120	100	80	~ 10m	—	—	—	—	—	—	
~ 500	10	230	170	120	100	80	~ 10m	—	—	—	—	—	—	
~ 600	10	230	170	120	100	80	~ 10m	—	—	—	—	—	—	
~ 650	20	230	170	120	100	80	~ 10m	—	—	—	—	—	—	
~ 400	10	290	220	155	130	100	11~20m	—	—	—	—	—	—	
~ 500	10	290	220	155	130	100	11~20m	—	—	—	—	—	—	
~ 600	10	290	220	155	130	100	11~20m	—	—	—	—	—	—	
~ 650	20	290	220	155	130	100	11~20m	—	—	—	—	—	—	

- The above lengths are the minimum necessary of the bulb to be inserted into the fluid to be measured.
- Bulb length should be over the above length and specified in 5mm steps.
- For plain type, make the sum of 40mm added to the bulb minimum insertion dimension given in the table the minimum length.

The above minimum insertion length is the length without thermowell.
With thermowell, 25mm is added to the above length.
The minimum length of the plain type bulb is the minimum length of the above table plus 40mm.

Thermometers with Contact Switch (Indoor · Remote type)

TK63·64·66

Liquid / Gas filled dial thermometer

Mounting hole type

Dimensions

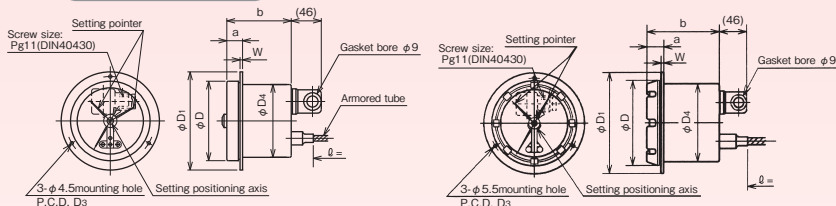
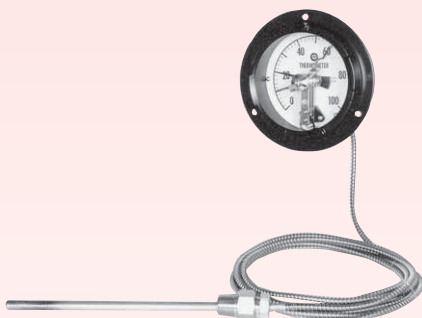

TK63

TK64 · TK66

Model	Dial size	Dimensions							Panel cut dimensions
		D	D ₁	D ₃	D ₄	a	b	W	
TK63	75	85	105	95	79	16	76	3	φ81±1
TK64	100	112	136	122	104	19	79	3	φ106±1
TK66	150	165	192	178	158	21	85	4	φ160±1

Specifications

Item	Description
Manufacturing range	-70 to 50°C → 0 to 650°C
Case	Construction: Indoor / Equivalent to IP32, Material: AC7A, Finish: Black
Wetted parts material	Bulb: SUS304, Connection / Flange: SUS304
Switch used	Contact switch (Open low contact pressure)
Number of contacts	One contact / Two contacts
Setting	External adjustment
Lead length	1 · 2 · 3 · 4 · 5 · 8 · 10 · 15 · 20 (m) Standard 3m Max.: Bimetal compensation 5m (400°C or more: 20m) Lead compensation 20m (φ75, φ100: Not available)
Compensation	TK63, TK64 Bimetal compensation TK66 Bimetal compensation, lead compensation (For 400°C or more, bimetal compensation only)
Connection	R ¹ / ₂ , R ³ / ₄ , 1/2NPT, G ¹ / ₂ B, G ³ / ₄ B 1/2 is not available with φ16 bulb and φ19, φ23 thermowell.
Flange	JIS10K20ARF, JIS10K25ARF, ANSI1B150RF, ANSI1B300RF
Connection	Without thermowell: Union type, Slide type With thermowell: Double socket union type: R ¹ / ₂ , 1/2NPT (Connection) Double socket slide type: R ¹ / ₂ , 1/2NPT (Connection)
Accuracy	Indication: Within ±2%F.S. *Accuracy when 1 contact is free. Reproducibility: Within ±2%F.S. Setting: Within ±3%F.S.
Dead band	Within 4%F.S.
Ambient temperature error	Within ±2%F.S. / 15°C

Range / Bulb DIA. / Bulb length

Range °C	Minimum graduation °C	Bulb minimum insertion length mm											Bulb maximum length mm	
		Bimetal compensation							φ150 lead compensation					
		Bulb outer diameter					Lead length	Bulb outer diameter				Lead length		
φ8	φ10	φ12	φ13	φ16	φ8	φ10		φ12	φ13	φ16				
-70 ~ 50	2	50	45	40	40	50	~ 5m	50	45	40	40	50	~20m	500
-70 ~ 100	5	40	40	40	40	40	~ 5m	40	40	40	40	40	~20m	
-50 ~ 50	2	55	45	40	40	55	~ 5m	55	45	40	40	55	~20m	
-30 ~ 50	2	65	55	45	40	40	~ 5m	65	55	45	40	40	~20m	
-20 ~ 100	2	50	45	40	40	50	~ 5m	50	45	40	40	50	~20m	
-10 ~ 50	1	70	60	50	45	40	~ 5m	70	60	50	45	40	~20m	
0 ~ 50	1	70	60	50	45	40	~ 5m	70	60	50	45	40	~20m	
~ 60	1	65	55	45	40	40	~ 5m	65	55	45	40	40	~20m	
~ 80	2	65	55	45	40	40	~ 5m	65	55	45	40	40	~20m	
~ 100	2	55	45	40	40	55	~ 5m	55	45	40	40	55	~20m	
~ 120	2	50	45	40	40	50	~ 5m	50	45	40	40	50	~20m	
~ 150	2	40	40	40	40	40	~ 5m	40	40	40	40	40	~20m	
~ 200	5	40	40	40	40	40	~ 5m	40	40	40	40	40	~20m	
~ 250	5	40	40	40	40	40	~ 5m	40	40	40	40	40	~20m	
~ 300	5	40	40	40	40	40	~ 5m	40	40	40	40	40	~20m	
~ 400	10	230	170	120	100	80	~10m	—	—	—	—	—	—	
~ 500	10	230	170	120	100	80	~10m	—	—	—	—	—	—	
~ 600	10	230	170	120	100	80	~10m	—	—	—	—	—	—	
~ 650	20	230	170	120	100	80	~10m	—	—	—	—	—	—	
~ 400	10	290	220	155	130	100	11~20m	—	—	—	—	—	Bulb outer diameter φ8, 16=1000, φ10, 12, 13=3000	
~ 500	10	290	220	155	130	100	11~20m	—	—	—	—	—		
~ 600	10	290	220	155	130	100	11~20m	—	—	—	—	—		
~ 650	20	290	220	155	130	100	11~20m	—	—	—	—	—		

- The above lengths are the minimum necessary of the bulb to be inserted into the fluid to be measured.
- Bulb length should be over the above length and specified in 5mm steps.
- For plain type, make the sum of 40mm added to the bulb minimum insertion dimension given in the table the minimum length.

The above minimum insertion length is the length without thermowell.
With thermowell, 25mm is added to the above length.
The minimum length of the plain type bulb is the minimum length of the above table plus 40mm.

Thermometers with Contact Switch (Indoor · Remote type)

TK73·74·76

Liquid / Gas filled dial thermometer

Mounting clamp type

Dimensions

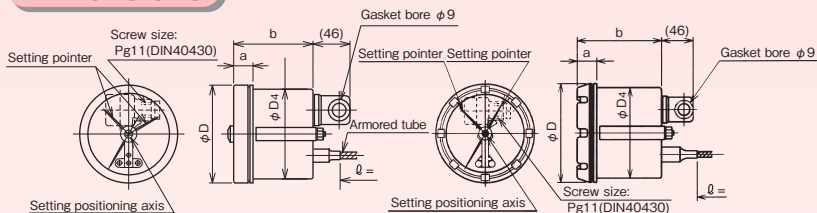

TK73

TK74 · TK76

Model	Dial size	Dimensions							Panel cut dimensions
		D	D ₁	D ₃	D ₄	a	b	W	
TK73	75	85	105	95	79	16	76	3	φ81±1
TK74	100	112	136	122	104	19	79	3	φ106±1
TK76	150	165	192	178	158	21	85	4	φ160±1

Specifications

Item	Description	
Manufacturing range	-70 to 50°C → 0 to 650°C	
Case	Construction: Indoor / Equivalent to IP32, Material: AC7A, Finish: Black	
Wetted parts material	Bulb: SUS304, Connection / Flange: SUS304	
Switch used	Contact switch (Open low contact pressure)	
Number of contacts	One contact / Two contacts	
Setting	External adjustment	
Lead length	1 · 2 · 3 · 4 · 5 · 8 · 10 · 15 · 20 (m) Standard 3m Max.: Bimetal compensation 5m (400°C or more: 20m) Lead compensation 20m (φ75, φ100: Not available)	
Compensation	TK73, TK74 Bimetal compensation TK76 Bimetal compensation, lead compensation (For 400°C or more, bimetal compensation only)	
Connection	R ¹ / ₂ , R ³ / ₄ , 1/2NPT, G ¹ / ₂ B, G ³ / ₄ B 1/2 is not available with φ16 bulb and φ19, φ23 thermowell.	
Flange	JIS10K20ARF, JIS10K25ARF, ANSI1B150RF, ANSI1B300RF	
Connection	Without thermowell	Union type, Slide type
	With thermowell	Double socket union type: R ¹ / ₂ , 1/2NPT (Connection) Double socket slide type: R ¹ / ₂ , 1/2NPT (Connection)
Accuracy	Indication	Within ±2%F.S. *Accuracy when 1 contact is free.
	Reproducibility	Within ±2%F.S.
	Setting	Within ±3%F.S.
Dead band	Within 4%F.S.	
Ambient temperature error	Within ±2%F.S. / 15°C	

Range / Bulb DIA. / Bulb length

Range °C	Minimum graduation °C	Bulb minimum insertion length mm											Bulb maximum length mm	
		Bimetal compensation						φ150 lead compensation						
		Bulb outer diameter					Lead length	Bulb outer diameter						Lead length
φ8	φ10	φ12	φ13	φ16	φ8	φ10		φ12	φ13	φ16				
-70 ~ 50	2	50	45	40	40	50	~ 5m	50	45	40	40	50	~20m	500
-70 ~ 100	5	40	40	40	40	40	~ 5m	40	40	40	40	40	~20m	
-50 ~ 50	2	55	45	40	40	55	~ 5m	55	45	40	40	55	~20m	
-30 ~ 50	2	65	55	45	40	40	~ 5m	65	55	45	40	40	~20m	
-20 ~ 100	2	50	45	40	40	50	~ 5m	50	45	40	40	50	~20m	
-10 ~ 50	1	70	60	50	45	40	~ 5m	70	60	50	45	40	~20m	
0 ~ 50	1	70	60	50	45	40	~ 5m	70	60	50	45	40	~20m	
~ 60	1	65	55	45	40	40	~ 5m	65	55	45	40	40	~20m	
~ 80	2	65	55	45	40	40	~ 5m	65	55	45	40	40	~20m	
~ 100	2	55	45	40	40	55	~ 5m	55	45	40	40	55	~20m	
~ 120	2	50	45	40	40	50	~ 5m	50	45	40	40	50	~20m	
~ 150	2	40	40	40	40	40	~ 5m	40	40	40	40	40	~20m	
~ 200	5	40	40	40	40	40	~ 5m	40	40	40	40	40	~20m	
~ 250	5	40	40	40	40	40	~ 5m	40	40	40	40	40	~20m	
~ 300	5	40	40	40	40	40	~ 5m	40	40	40	40	40	~20m	
~ 400	10	230	170	120	100	80	~10m	—	—	—	—	—	—	
~ 500	10	230	170	120	100	80	~10m	—	—	—	—	—	—	
~ 600	10	230	170	120	100	80	~10m	—	—	—	—	—	—	
~ 650	20	230	170	120	100	80	~10m	—	—	—	—	—	—	
~ 400	10	290	220	155	130	100	11~20m	—	—	—	—	—	Bulb outer diameter φ8, 16=1000, φ10, 12, 13=3000	
~ 500	10	290	220	155	130	100	11~20m	—	—	—	—	—		
~ 600	10	290	220	155	130	100	11~20m	—	—	—	—	—		
~ 650	20	290	220	155	130	100	11~20m	—	—	—	—	—		

- The above lengths are the minimum necessary of the bulb to be inserted into the fluid to be measured.
- Bulb length should be over the above length and specified in 5mm steps.
- For plain type, make the sum of 40mm added to the bulb minimum insertion dimension given in the table the minimum length.

The above minimum insertion length is the length without thermowell.
With thermowell, 25mm is added to the above length.
The minimum length of the plain type bulb is the minimum length of the above table plus 40mm.

TK5·6·7

Thermometers with Electric Contact

Model number configuration

Please specify the model number, each specs and the range for ordering.

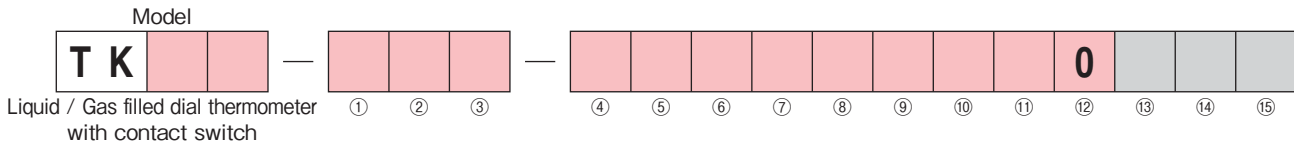

Model number		Selective spec.	Additional spec. (Option)
--------------	--	-----------------	---------------------------

Type	5	Surface mounting type
	6	Remote type (Hole mounting)
	7	Remote type (Clamp mounting)

Size	3	φ 75
	4	φ 100
	6	φ 150

① Thermowell inside screws For with thermowell, please specify the thermowell type on a separate page.	0	Without thermowell	Welded type	Drilled type		Welded type
		With thermowell		Straight	Taper	
	1	Inside screws: Standard (W22 thread 14)	SW11(SW10)	SW41(SW40)	SW71(SW70)	SW81
	2	Inside screws: Rc1/2 double socket	SW12	SW42	SW72	SW82
	3	Inside screws: 1/2NPT double socket	SW13	SW43	SW73	—
	4	Inside screws: G1/2 double socket	SW14	SW44	SW74	—
5	Inside screws: Rc3/4 double socket	SW15	SW45	SW75	—	

② Connecting part	0	Union type
	1	Slide type (Direct type and φ 16 bulb are not available when maximum temperature of the temperature range exceeds 400°C.)
	4	Plain type

③ Connecting screws	0	R1/2	H	JIS10K50ARF
	1	R3/4	J	JIS20K20ARF
	2	1/2NPT	K	JIS20K25ARF
	3	G1/2B	L	JIS10K15AFF
	4	G3/4B	M	JIS10K20AFF
	5	JIS10K20ARF	N	JIS10K25AFF
	6	JIS10K25ARF	P	ANSI3/4B150RF
	7	ANSI1B150RF	Q	ANSI3/4B300RF
	8	ANSI1B300RF	R	ANSI1B600RF
	A	Fixing screws (W22 thread 14)	S	ANSI 1 1/2B150RF
	B	R3/8	T	ANSI 1 1/2B300RF
	C	R1	U	ANSI 1 1/2B600RF
	D	3/4NPT	W	JPI 1B150RF
	E	1NPT	X	JPI 1B300RF
	F	JIS10K15ARF	Y	JPI 1B600RF
	G	JIS10K40ARF	Z	Plain type

Please specify the temperature range and units separately besides selection of range code.

④ Range °C	1	0 to 50, 60, 80, 100, 120, 150 Direct type of 120°C and 150°C is not available
	2	0 to 200, 250, 300 Direct type not available
	3	0 to 400, 500 (Gas filled dial thermometer only) Direct type not available
	4	0 to 600, 650 (Gas filled dial thermometer only) Direct type not available
	5	-10 to 50, -30 to 50, -50 to 50, -10 to 100
	6	-70 to 50, -20 to 100, -70 to 100

⑤ Bulb material	1	SUS304
	2	SUS316
	X	With thermowell

⑥ Bulb DIA.	1	d=φ 8	Direct type for slide type not available
	2	d=φ 10	Direct type for slide type not available
	3	d=φ 12	Direct type for slide type not available
	4	d=φ 13	Direct type for slide type not available
	5	d=φ 16	Slide type not available
	X	With thermowell	

⑦ Bulb length	A	Minimum dimension to 500mm
	B	505 to 600mm
	C	605 to 700mm
	D	705 to 800mm
	E	805 to 900mm
	F	905 to 1000mm
	X	Other specified (/100mm) With thermowell

⑧ Compensation	1	Bimetal compensation
	2	Lead compensation φ 75, 100, not available

⑨ Lead type	0	Direct type
	2	Armored tube B (SUS430) (Standard)
	B	Armored tube B (SUS304)
	E	Armored tube B (SUS316)

⑩ Lead length	Bimeta		Lead
	0	0	Direct type
	A	ア	Up to 3m
	B	イ	Up to 4m
	C	ウ	Up to 5m
	D	エ	Up to 6m
	E	オ	Up to 7m
	F	カ	Up to 8m
	G	キ	Up to 9m
	H	ク	Up to 10m
9	9	Other specified (/m)	

⑪ Contact	A	H: Upper limit type with 1 contact
	B	L: Lower limit type with 1 contact
	C	HL: Upper & lower limit type with 2 contacts

⑫ Electric wire outlet	0	DIN φ 9 (Standard)
------------------------	---	--------------------

⑬ Kind of thermowell	1	Welded type
	4	Drilled type straight
	7	Drilled type taper
	8	Welded flange

⑭ Thermowell inside screws	0	For slide type. General products: Not available
	1	W22 thread 14
	2	Rc1/2
	3	1/2NPT
	4	G1/2
5	Rc3/4	General products: Not available

[Manufacturing range]

- For φ 150, lead compensation available.
- Thermowell inside screws: For slide type, direct type and φ 16 bulb are not available.

* When ordering, please specify the bulb length and lead length.

* The thermowell model composition is SW ⑬⑭.

* For with thermowell, please refer to P 16 to thermowell manufacturing specifications and specify the SW model also.

* Please contact us for direct type.

* Specify "X" if there is no specification item.

⑮ Documents	0	Nii
	1	Required (Please specify the desired documents separately.) Submission drawings, instruction manual, inspection procedure, mill sheet, test report (1 pc 1 copy), traceability / inspection certificate, strength calculation, attended inspection

Explosion-proof Thermometer with Contact Switch

(Surface mounting type)

TD10

Liquid / Gas filled dial thermometer

Dimensions

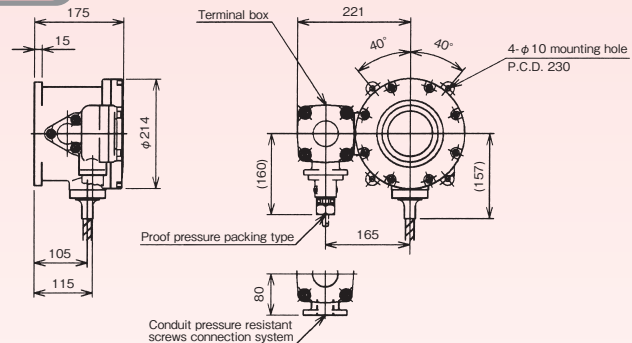
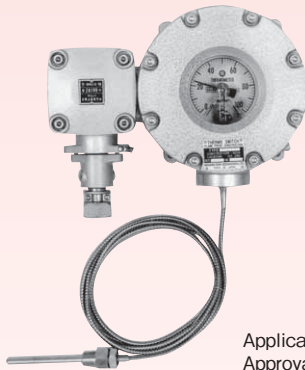

Applicable model: d2G4
Approval number for labor ministry inspection: No.T24199
(TD11 type use product)
Weight: Approx. 11kg (Indicator part)

Specifications

Item	Description		
Manufacturing range	-70 to 50°C → 0 to 600°C		
Indication dial	Local indicator		
Switch used	Contact switch (Open low contact pressure)		
Number of contacts	One contact / Two contacts	Electric rating	
Setting	Internal adjustment		
Lead length	1 · 2 · 3 · 4 · 5 (m) Standard 3m Max. 5m, For 400°C or more, 10m		
Case	Construction: Drip-proof / Equivalent to IP54, Material: AC7A, Finish: Grey crystal		
Wetted parts material	Bulb: SUS304, Connection / Flange: SUS304		
Compensation	Bimetal compensation		
Connection	R $\frac{1}{2}$, R $\frac{3}{4}$, $\frac{1}{2}$ NPT, G $\frac{1}{2}$ B, G $\frac{3}{4}$ B $\frac{1}{2}$ is not available with ϕ 16 bulb and ϕ 19, ϕ 23 thermowell.		
Flange	JIS10K20ARF, JIS10K25ARF, ANSI11B150RF, ANSI1B300RF		
Connection	Without thermowell	Union type, Slide type	Slide type is not available with ϕ 16 bulb. When the maximum temperature in the temperature range exceeds 400°C, slide type is not available.
	With thermowell	Double socket union type: R $\frac{1}{2}$, $\frac{1}{2}$ NPT (Connection) Double socket slide type: R $\frac{1}{2}$, $\frac{1}{2}$ NPT (Connection)	
Accuracy	Indication	Within $\pm 2\%$ F.S. *Accuracy when 1 contact is free.	
	Reproducibility	Within $\pm 2\%$ F.S.	
	Setting	Within $\pm 3\%$ F.S.	
Dead band	Within 4%F.S.		
Ambient temperature error	Within $\pm 2\%$ F.S. / 15°C		

Range / Bulb DIA. / Bulb length

Range °C	Minimum graduation °C	Bulb length (L) mm					Maximum
		Minimum insertion length					
		d = ϕ 8	d = ϕ 10	d = ϕ 12	d = ϕ 13	d = ϕ 16	
-70~ 50	2	50	45	40	40	50	500
-70~ 100	5	40	40	40	40	40	
-50~ 50	2	55	45	40	40	55	
-30~ 50	2	65	55	45	40	40	
-20~ 100	2	50	45	40	40	50	
-10~ 50	1	70	60	50	45	40	
0~ 50	1	70	60	50	45	40	
~ 60	1	65	55	45	40	40	
~ 80	2	65	55	45	40	40	
~ 100	2	55	45	40	40	55	
~ 120	2	50	45	40	40	50	
~ 150	2	40	40	40	40	40	
~ 200	5	40	40	40	40	40	
~ 250	5	40	40	40	40	40	
~ 300	5	40	40	40	40	40	
~ 400	10	230	170	120	100	80	
~ 500	10	230	170	120	100	80	
~ 600	10	230	170	120	100	80	

● The above lengths are the minimum necessary of the bulb to be inserted into the fluid to be measured.
● Bulb length should be over the above length and specified in 5mm steps.
● For plain type, make the sum of 40mm added to the bulb minimum insertion dimension given in the table the minimum length.

The above minimum insertion length is the length without thermowell.
With thermowell, 25mm is added to the above length.

Explosion-proof

Explosion-proof construction

Explosion-proof construction is a totally enclosed construction such that even if the explosive gas explodes inside the container, the container withstands the force of the explosion and there is no danger of ignition of external explosive gases.

Application range: d2G4

- 1) Explosion-proof construction: d
- 2) Explosion class : 2
- 3) Ignitability : G 4
- 4) Hazardous areas : Zone 1 or zone 2
- 5) Objective industries : Petrochemical, chemical fiber, synthetic resin, ethylene, methanol, dielectric products manufacturing, liquefied gas, electric furnace, pharmaceuticals, paints, ammonium sulfate, soda, other measurement medium or industries in which there is the danger of ignition and explosion.

Classification of hazardous areas:

Hazardous area	Contents
Zone 0	A place where hazardous atmosphere is continuously present or present for a long period under ordinary circumstances.
Zone 1	A place where hazardous atmosphere is likely to occur under ordinary circumstances.
Zone 2	A place where hazardous atmosphere is likely to occur under abnormal circumstances.

Classification of explosion:

Explosion class	Minimum gap with a 25mm length of path which permits the flame propagation
1	Over 0.6mm
2	0.4mm to 0.6mm
3	Up to 0.4mm

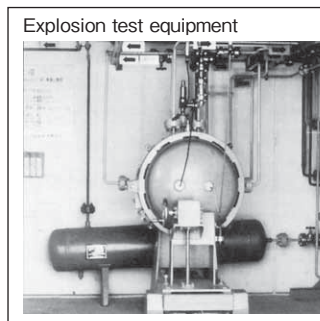

Classification of ignition groups:

Ignition class	Ignition point	Limits of temperature rise (deg)
G 1	Over 450°C	320
G 2	300°C to 450°C	200
G 3	200°C to 300°C	120
G 4	135°C to 200°C	70
G 5	100°C to 135°C	40
G 6	85°C to 100°C	30

The standard ambient temperature range of an electric instrument in the normal usage state shall be 40°C.

Example of classification of typical explosive gases:

Explosion class	Ignition class	G 1	G 2	G 3	G 4	G 5	G 6
		Acetone	Ethanol	Gasoline	Acetaldehyde		
1	Ammonia	Isopentyl acetat	Hexane	Ethyl ether			
	Carbon monoxide	1-Butanol					
	Ethane	Butane					
	Acetic acid	Acetic anhydride					
	Ethyl acetate						
	Toluene						
	Propane						
	Benzene						
	Methanol						
	Methane						
2	Carbon gas	Ethylene					
		Ethylene oxide					
3	Water gas	Acetylene				Carbon dioxide	
	Hydrogen						

Explosion-proof

Method of leading in of external conductors and cable to a terminal box

Leading in of external conductors and cable to a terminal box uses a pressure resistant gasket method and a conduit method.

1) Flame-proof gasket type

For rubber, plastic tube, etc. lead in.

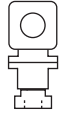
Gasket inner dia. (d)	Cable outer dia. (d)	Cable protection tube connection
10.5	9.4	PF 1/2 PF 3/4
	9.9	
	10.1	
12	10.5	PF 3/4 PF 1
	11.0	
	11.5	
14	11.9	
	12.0	
	12.5	
	12.6	
15.5	13.1	PF 3/4 PF 1
	13.5	
	13.6	
	14.5	
16.5	15.6	

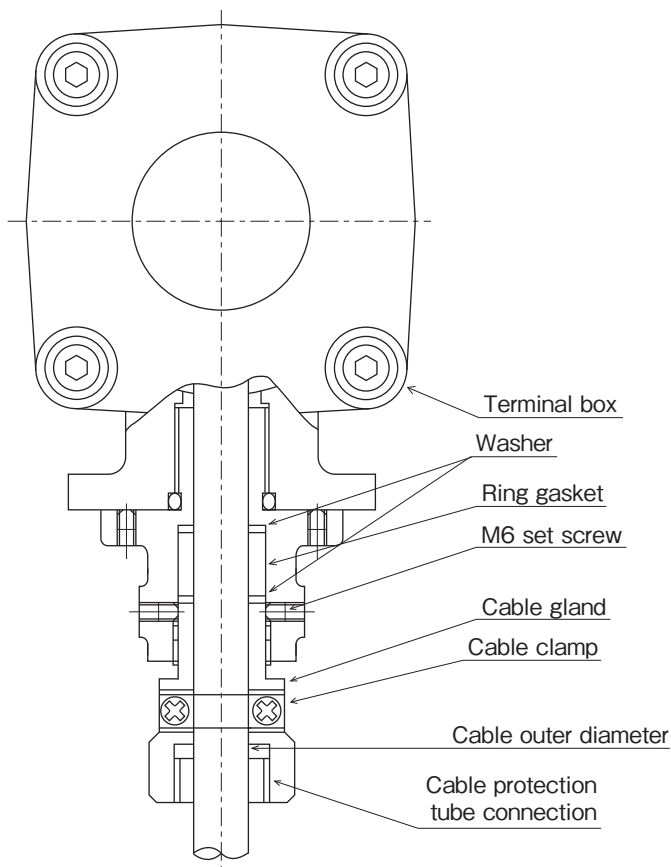

2) Conduit pressure resistant screw connection system conduit

For leading in of conduit.

When metal conduit wiring is performed, sealing like that shown below must be performed near the terminal box and the conduit connection.

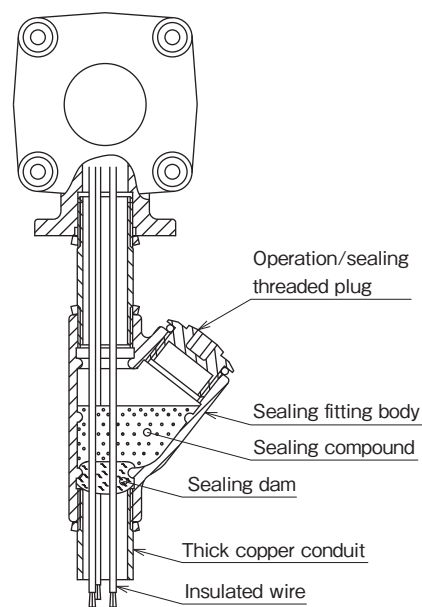
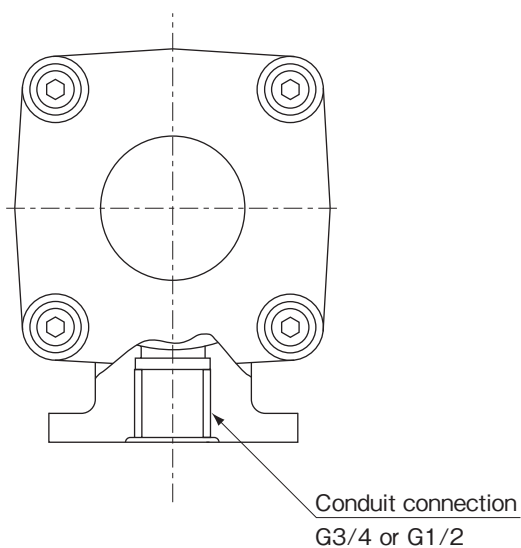

Note) Use the 600V vinyl insulated electric wire specified by JIS C 3307 or better as the metal conduit electric wire. Do not use cable of cable type cable.

TD10

Thermometers with Electric Contact

Model number configuration

Please specify the model number, each specs and the range for ordering.

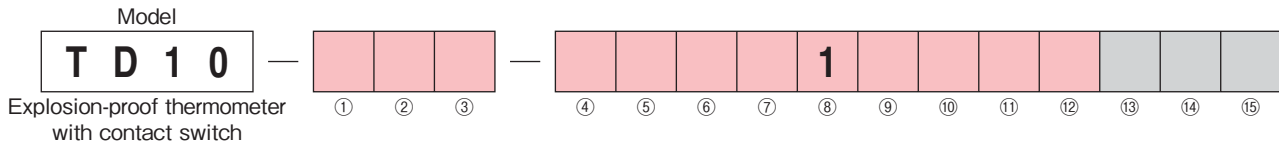

Model number		Selective spec.										Additional spec. (Option)							
① Thermowell inside screws For with thermowell, please specify the thermowell type on a separate page.	0	Without thermowell																	
		With thermowell										Welded type							
	1	Inside screws: Standard (W22 thread 14)										Drilled type							
	2	Inside screws: Rc1/2 double socket										Straight							
	3	Inside screws: 1/2NPT double socket										Taper							
	4	Inside screws: G1/2 double socket										Flange							
5	Inside screws: Rc3/4 double socket										SW11(SW10)		SW41(SW40)		SW71(SW70)		SW81		
												SW12		SW42		SW72		SW82	
												SW13		SW43		SW73		—	
												SW14		SW44		SW74		—	
												SW15		SW45		SW75		—	
② Connecting part	0	Union type																	
	1	Slide type (ϕ 16 bulb are not available when maximum temperature of the temperature range exceeds 400°C.)																	
	4	Plain type																	
③ Connecting screws	0	R1/2		H		JIS10K50ARF													
	1	R3/4		J		JIS20K20ARF													
	2	1/2NPT		K		JIS20K25ARF													
	3	G1/2B		L		JIS10K15AFF													
	4	G3/4B		M		JIS10K20AFF													
	5	JIS10K20ARF		N		JIS10K25AFF													
	6	JIS10K25ARF		P		ANSI3/4B15ORF													
	7	ANSI1B15ORF		Q		ANSI3/4B30ORF													
	8	ANSI1B30ORF		R		ANSI1B60ORF													
	A	Fixing screws (W22 thread 14)		S		ANSI 1 1/2B15ORF													
	B	R3/8		T		ANSI 1 1/2B30ORF													
	C	R1		U		ANSI 1 1/2B60ORF													
	D	3/4NPT		W		JPI 1B15ORF													
	E	1NPT		X		JPI 1B30ORF													
F	JIS10K15ARF		Y		JPI 1B60ORF														
G	JIS10K40ARF		Z		Plain type														
④ Range °C	1	0 to 50, 60, 80, 100, 120, 150																	
	2	0 to 200, 250, 300																	
	3	0 to 400, 500 (Gas filled dial thermometer only)																	
	4	0 to 600 (Gas filled dial thermometer only)																	
	5	-10 to 50, -30 to 50, -50 to 50																	
	6	-70 to 50, -70 to 100, -20 to 100																	
⑤ Bulb material	1	SUS304																	
	2	SUS316																	
	X	With thermowell																	
⑥ Bulb DIA.	1	d= ϕ 8																	
	2	d= ϕ 10																	
	3	d= ϕ 12																	
	4	d= ϕ 13																	
	5	d= ϕ 16 Slide type not available																	
	X	With thermowell																	
⑦ Bulb length	A	Minimum dimension to 500mm																	
	B	505 to 600mm																	
	C	605 to 700mm																	
	D	705 to 800mm																	
	E	805 to 900mm																	
	F	905 to 1000mm																	
	X	Other specified (/100mm) With thermowell																	
⑧ Compensation	1	Bimetal compensation																	
⑨ Lead type	2	Armored tube B (SUS430) (Standard)																	
	B	Armored tube B (SUS304)																	
	E	Armored tube B (SUS316)																	
⑩ Lead length	A	Up to 3m																	
	B	Up to 4m																	
	C	Up to 5m																	
	D	Up to 6m																	
	E	Up to 7m																	
	F	Up to 8m																	
	G	Up to 9m																	
	H	Up to 10m																	
	9	Other specifications (/m)																	
⑪ Contact	A	H: Upper limit type with 1 contact																	
	B	L: Lower limit type with 1 contact																	
	C	HL: Upper & lower limit type with 2 contacts																	
⑫ Electric wire outlet	C	Conduit type G3/4 (Standard)																	
	カ	Proof pressure packing type, G1/2×12																	
	キ	Proof pressure packing type, G3/4×10.5																	
	コ	Proof pressure packing type, G3/4×14																	
⑬ Kind of thermowell	1	Welded type																	
	4	Drilled type straight																	
	7	Drilled type taper																	
	8	Welded flange																	
⑭ Thermowell inside screws	0	For slide type. General products: Not available																	
	1	W22 thread 14																	
	2	Rc1/2																	
	3	1/2NPT																	
	4	G1/2																	
5	Rc3/4																		
⑮ Documents	0	Nil																	
	1	Required (Please specify the desired documents separately.) Submission drawings, instruction manual, inspection procedure, mill sheet, test report (1 pc 1 copy), traceability / inspection certificate, strength calculation, attended inspection																	

Please specify the temperature range and units separately besides selection of range code.

[Manufacturing range]

• Thermowell inside screws: For slide type, ϕ 16 bulb is not available.

* When ordering, please specify the bulb length and lead length.

* The thermowell model composition is SW ⑬⑭.

* For with thermowell, please refer to P ⑬⑭ to thermowell manufacturing specifications and specify the SW model also.

*Specify "X" if there is no specification item.

For transformer Thermometers with Contact Switch

(Indoor • Surface mounting type)

TW83•84

Liquid / Gas filled dial thermometer



Dimensions

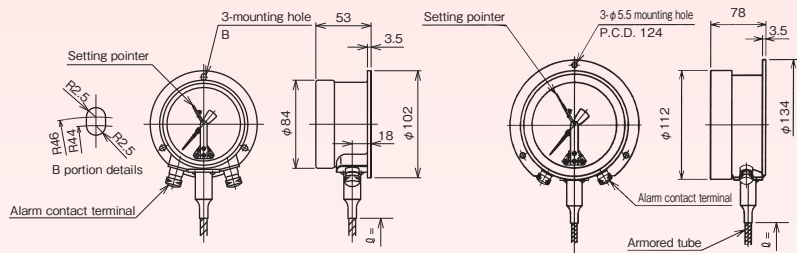

TW83 Size 75

TW84 Size 100

Specifications

Item		Description	
Manufacturing range		-70 to 100°C → 0 to 500°C	
Switch used		Contact switch (Open low contact pressure)	
Number of contacts		One contact	
Setting		Internal adjustment	Electric rating
Maximum pointer		Option	
Maximum lead length		5 m (Standard 3m)	
Case		Construction: Indoor / Equivalent to IP42, Material: Aluminum alloy, Finish: Black	
Wetted parts material		Bulb: SUS304, Connection / Flange: SUS304	
Compensation		Bimetal compensation	
Connection		R $\frac{1}{2}$, R $\frac{3}{4}$, $\frac{1}{2}$ NPT, G $\frac{1}{2}$ B, G $\frac{3}{4}$ B $\frac{1}{2}$ is not available with ϕ 16 bulb and ϕ 19, ϕ 23 thermowell.	
Flange		JIS10K20ARF, JIS10K25ARF, ANSI1B150RF, ANSI1B300RF	
Connection	Without thermowell	Union type, Slide type	Slide type is not available with ϕ 16 bulb. When the maximum temperature of temperature range exceeds 400°C, slide type is not available.
	With thermowell	Double socket union type: R $\frac{1}{2}$, $\frac{1}{2}$ NPT (Connection) Double socket slide type: R $\frac{1}{2}$, $\frac{1}{2}$ NPT (Connection)	
Accuracy	Indication	Within $\pm 2\%$ F.S. *Accuracy when 1 contact is free.	
	Reproducibility	Within $\pm 2\%$ F.S.	
	Setting	Within $\pm 4\%$ F.S.	
Dead band		Within 7 %F.S.	
Ambient temperature error		Within $\pm 2\%$ F.S. / 15°C	

●Please use with contact switch normally open.

*For transformer: 2000V AC for 1 minute

Range / Bulb DIA. / Bulb length

Range °C	Minimum graduation °C	Bulb length (L) mm					Maximum
		Minimum insertion length					
		d = ϕ 8	d = ϕ 10	d = ϕ 12	d = ϕ 13	d = ϕ 16	
-70~100	5	40	40	40	40	40	500
-20~100	2	50	45	40	40	50	
0~ 50	1	70	60	50	45	40	
~100	2	55	45	40	40	55	
~120	2	50	45	40	40	50	
~150	2	40	40	40	40	40	
~200	5	40	40	40	40	40	
~300	5	40	40	40	40	40	
~500	10	230	170	120	100	80	
		d = ϕ 8, ϕ 16 1000 d = ϕ 10, ϕ 12, ϕ 13 3000					

●The above lengths are the minimum necessary of the bulb to be inserted into the fluid to be measured.

●Bulb length should be over the above length and specified in 5mm steps.

●For plain type, make the sum of 40mm added to the bulb minimum insertion dimension given in the table the minimum length.

The above minimum insertion length is the length without thermowell.
With thermowell, 25mm is added to the above length.

For transformer Thermometers with Contact Switch

TW54

Liquid / Gas filled dial thermometer

〈Waterproof and moisture protected • Surface mounting type〉



Dimensions

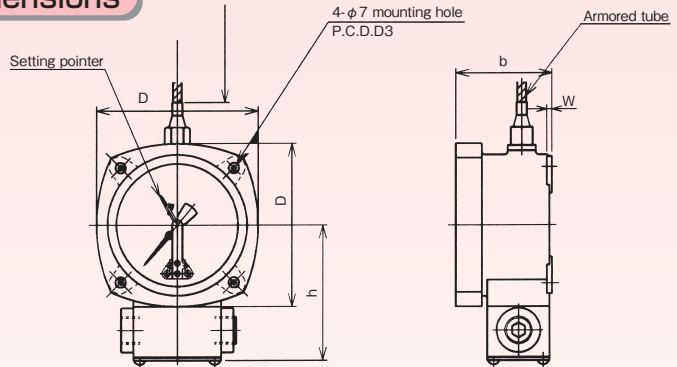

Model	Dial size	Dimensions				
		D	D ₃	b	W	h
TW54	100	125	126	74	4	103

Specifications

Item		Description	
Manufacturing range		-70 to 100°C → 0 to 500°C	
Switch used		Contact switch (Open low contact pressure)	
Number of contacts		One contact / Two contacts	
Setting		Internal adjustment	Electric rating
Maximum pointer		Option (Two contacts is not available)	
Maximum lead length		5 m (Standard 3m)	
Case		Construction: Waterproof / Equivalent to IP65, Material: Aluminum alloy, Finish: Black	
Wetted parts material		Bulb: SUS304, Connection / Flange: SUS304	
Compensation		Bimetal compensation	
Connection		R $\frac{1}{2}$, R $\frac{3}{4}$, $\frac{1}{2}$ NPT, G $\frac{1}{2}$ B, G $\frac{3}{4}$ B $\frac{1}{2}$ is not available with ϕ 16 bulb and ϕ 19, ϕ 23 thermowell.	
Flange		JIS10K20ARF, JIS10K25ARF, ANSI1B150RF, ANSI1B300RF	
Connection	Without thermowell	Union type, Slide type	Slide type is not available with ϕ 16 bulb. When the maximum temperature of temperature range exceeds 400°C, slide type is not available.
	With thermowell	Double socket union type: R $\frac{1}{2}$, $\frac{1}{2}$ NPT (Connection) Double socket slide type: R $\frac{1}{2}$, $\frac{1}{2}$ NPT (Connection)	
Accuracy	Indication	Within $\pm 2\%$ F.S. *Accuracy when 1 contact is free.	
	Reproducibility	Within $\pm 2\%$ F.S.	
	Setting	Within $\pm 4\%$ F.S.	
Dead band		Within 7 %F.S.	
Ambient temperature error		Within $\pm 2\%$ F.S. / 15°C	

● Please use with contact switch normally open.

● For 2 contacts switches, these circuits do not operate independently because of the common pole.

* For transformer: 2000V AC for 1 minute

Range / Bulb DIA. / Bulb length

Range °C	Minimum graduation °C	Bulb length (L) mm					Maximum
		Minimum insertion length					
		d = ϕ 8	d = ϕ 10	d = ϕ 12	d = ϕ 13	d = ϕ 16	
-70~100	5	40	40	40	40	40	500
-20~100	2	50	45	40	40	50	
0~ 50	1	70	60	50	45	40	
~100	2	55	45	40	40	55	
~120	2	50	45	40	40	50	
~150	2	40	40	40	40	40	
~200	5	40	40	40	40	40	
~300	5	40	40	40	40	40	
~500	10	230	170	120	100	80	
		d = ϕ 8, ϕ 16 1000 d = ϕ 10, ϕ 12, ϕ 13 3000					

● The above lengths are the minimum necessary of the bulb to be inserted into the fluid to be measured.

● Bulb length should be over the above length and specified in 5mm steps.

● For plain type, make the sum of 40mm added to the bulb minimum insertion dimension given in the table the minimum length.

The above minimum insertion length is the length without thermowell.
With thermowell, 25mm is added to the above length.

Model number configuration

Please specify the model number, each specs and the range for ordering.

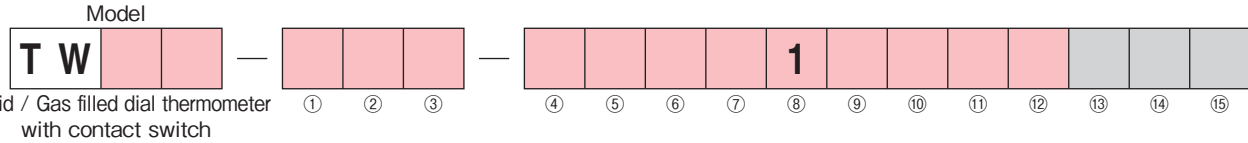

Model number			Selective spec.		Additional spec. (Option)
Type	5	4	φ 100 Waterproof and moisture resistant type: IP65		
	8	3	φ 75 Indoor type: IP42		
	8	4	φ 100 Indoor type: IP43		

① Thermowell inside screws For with thermowell, please specify the thermowell type on a separate page.	0	Without thermowell						
			With thermowell		Welded type	Drilled type	Welded type	
					Straight	Taper	Flange	
	1	Inside screws: Standard (W22 thread14) and for slide type			SW11(SW10)	SW41(SW40)	SW71(SW70)	SW81
	2	Inside screws: Rc1/2 double socket			SW12	SW42	SW72	SW82
	3	Inside screws: 1/2NPT double socket			SW13	SW43	SW73	—
4	Inside screws: G1/2 double socket			SW14	SW44	SW74	—	
5	Inside screws: Rc3/4 double socket			SW15	SW45	SW75	—	

② Connecting part	0	Union type	
	1	Slide type (φ 16 bulb are not available when maximum temperature of the temperature range exceeds 400°C.)	
	4	Plain type	

③ Connecting screws	0	R1/2	H	JIS10K50ARF
	1	R3/4	J	JIS20K20ARF
	2	1/2NPT	K	JIS20K25ARF
	3	G1/2B	L	JIS10K15AFF
	4	G3/4B	M	JIS10K20AFF
	5	JIS10K20ARF	N	JIS10K25AFF
	6	JIS10K25ARF	P	ANSI3/4B150RF
	7	ANSI1B150RF	Q	ANSI3/4B300RF
	8	ANSI1B300RF	R	ANSI1B600RF
	A	Fixing screws (W22 thread 14) union type only	S	ANSI 1 1/2B150RF
	B	R3/8	T	ANSI 1 1/2B300RF
	C	R1	U	ANSI 1 1/2B600RF
	D	3/4NPT	W	JPI 1B150RF
	E	1NPT	X	JPI 1B300RF
	F	JIS10K15ARF	Y	JPI 1B600RF
	G	JIS10K40ARF	Z	Plain type

Please specify the temperature range and units separately besides selection of range code.

④ Range °C	1	0 to 50, 100, 120, 150, 200, 300
	2	0 to 500 (Gas filled type only)
	4	-20 to 100, -70 to 100

⑤ Bulb material	1	SUS304
	2	SUS316
	X	With thermowell

⑥ Bulb DIA.	1	d=φ 8
	2	d=φ 10
	3	d=φ 12
	4	d=φ 13
	5	d=φ 16 Slide type not available
	X	With thermowell

⑦ Bulb length	A	Minimum dimension to 500mm
	B	505 to 600mm
	C	605 to 700mm
	D	705 to 800mm
	E	805 to 900mm
	F	905 to 1000mm
		Other specified (/100mm)
	X	With thermowell

⑧ Compensation	1	Bimetal compensation
----------------	---	----------------------

⑨ Lead type	2	Armored tube B (SUS430) (Standard)
	B	Armored tube B (SUS304)
	E	Armored tube B (SUS316)

⑩ Lead length	A	Up to 3m
	B	Up to 4m
	C	Up to 5m

⑪ Contact	A	H: Upper limit type with 1 contact
	B	L: Lower limit type with 1 contact
	C	HL: Upper & lower limit type with 2 contacts TW54 only

⑫ Electric wire outlet	O	Terminal for communication instrument TW83, 84 only
	B	G1/2 TW54 only

⑬ Kind of thermowell	1	Welded type
	4	Drilled type straight
	7	Drilled type taper
	8	Welded flange

⑭ Thermowell inside screws	0	For slide type. General products: Not available
	1	W22 thread 14
	2	Rc1/2
	3	1/2NPT
	4	G1/2
5	Rc3/4	General products: Not available

【Manufacturing range】

- Lead length: Max. 5m (Standard 3m)
- Thermowell inside screws: For slide type, φ 16 bulb is not available.

- * When ordering, please specify the bulb length and lead length.
- * The thermowell model composition is SW ⑬⑭.
- * For with thermowell, please refer to P ⑬⑭ to thermowell manufacturing specifications and specify the SW model also.

*Specify "X" if there is no specification item.

⑮ Documents	0	Nil
	1	Required (Please specify the desired documents separately.) Submission drawings, instruction manual, inspection procedure, mill sheet, test report (1 pc 1 copy), traceability certificate, inspection certificate, strength calculation, attended inspection

For Temperature Gauges

SW Thermo-well

When measuring temperature object flows, and the speed is fast, and the pressure is high, Temperature gauges are necessary to equip the thermo-well for their sensing part. And, in general application, Thermo-well is used for easy-maintenance.

The necessary conditions for thermo-well

- 1) Ability to withstand temperature, the pressure that is going to be measured (it contains a flow) fully.
- 2) Not raising corrosion, other chemical reaction by measuring temperature object.
- 3) With air tightness.
- 4) It isn't damaged even if receives sudden temperature change.
- 5) Ability to withstand mechanical power such as vibration, a shock enough.
- 6) Thermo-well oneself doesn't generate harmful gas to temperature gauges.
- 7) It can transmit the temperature changes to the sensing part rapidly.

Thermo-well has digging type and welding type (welding type is standard).
In addition, screw type and flange type are available by method of mounting.

Specifications

■Relation of thermo-well DIA. and bulb DIA., and manufacturing range of screws and flange

Outer DIA. (d_1)	Type	Inner DIA. (d_2)	Bulb outer DIA. (d)	Screw (T)			Flange JIS, ANSI, JPI
				$\frac{3}{8}$	$\frac{1}{2}$	$\frac{3}{4}$	
$\phi 12$	Drilled type	$\phi 8.5$	$\phi 8$	○	○	○	○
	Welded type			—	○	○	○
$\phi 15$	Drilled type	$\phi 10.5$	$\phi 10$	—	○	○	○
	Welded type	$\phi 11$		—	○	○	○
$\phi 19$	Drilled type	$\phi 13.5$	$\phi 13$	—	—	○	○
	Welded type			—	—	○	○
$\phi 23$	Drilled type	$\phi 16.5$	$\phi 16$	—	—	○	○
$\phi 19/\phi 23$ (Taper)	Drilled type	$\phi 13.5$	$\phi 13$	—	—	○	○

Inside screws (Connecting screws with thermometer): W22 thread 14 or Rc $\frac{1}{2}$

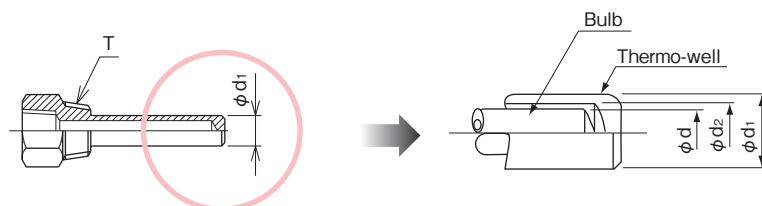

■Thermo-well material

SUS304, SUS316, SUS316L, Titanium, Hastelloy-B[®], and Monel-metal[®] are available.

Teflon[®], or Glass etc. coating is available.

Coated thermo-well is available with flange type only.

Specifications

■ Connection type and size

■ Thermo-well type and size

Screw type Union type

Taper Screw

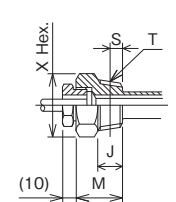

Double socket type

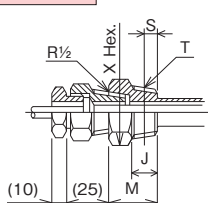

Straight Screw

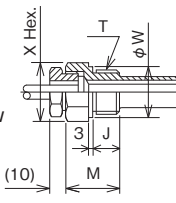

Double socket type

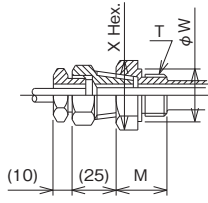

Flange type Union type

Standard

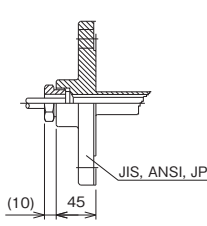

Double socket type

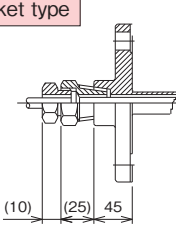

Welded type Weld the pipe as shown below.

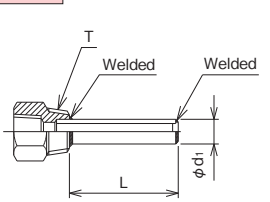

Drilled type (Straight)

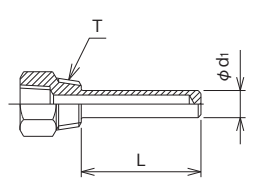

Drilled type (Taper)

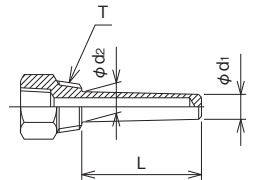

Welded type Weld the pipe as shown below.

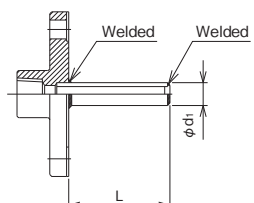

Drilled type (Straight)

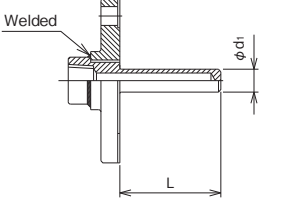

Drilled type (Taper)

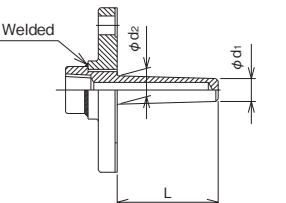

(mm)

T	J	S	W	X	M
R 1/2	18	8	-	27×31.2	43
R 3/4	20	9.5	-	30×34.6	45
G 1/2 B	18	-	32	32×37	43
G 3/4 B	20	-	36	36×41.6	45

Note) Please refer to JIS, ANSI, and JPI standard for flange size.

Welded type

Model number configuration

Please specify the model number and each specs for ordering.

Model	<div style="display: flex; justify-content: space-around; align-items: center;"> <div style="border: 1px solid black; padding: 2px; margin: 2px;">S W 1</div> <div style="border: 1px solid black; width: 20px; height: 20px; margin: 2px;"></div> <div style="border: 1px solid black; width: 20px; height: 20px; margin: 2px;"></div> <div style="border: 1px solid black; width: 20px; height: 20px; margin: 2px;"></div> <div style="border: 1px solid black; width: 20px; height: 20px; margin: 2px;"></div> <div style="border: 1px solid black; width: 20px; height: 20px; margin: 2px;"></div> <div style="border: 1px solid black; width: 20px; height: 20px; margin: 2px;"></div> <div style="border: 1px solid black; width: 20px; height: 20px; margin: 2px;"></div> <div style="border: 1px solid black; width: 20px; height: 20px; margin: 2px;"></div> <div style="border: 1px solid black; width: 20px; height: 20px; margin: 2px;"></div> <div style="border: 1px solid black; width: 20px; height: 20px; margin: 2px;"></div> <div style="border: 1px solid black; width: 20px; height: 20px; margin: 2px;"></div> <div style="border: 1px solid black; width: 20px; height: 20px; margin: 2px;"></div> <div style="border: 1px solid black; width: 20px; height: 20px; margin: 2px;"></div> <div style="border: 1px solid black; width: 20px; height: 20px; margin: 2px;"></div> <div style="border: 1px solid black; width: 20px; height: 20px; margin: 2px;"></div> </div>															
Welded Type Thermo-well	①	②	③	④	⑤	⑥	⑦	⑧	⑨	⑩	⑪	⑫	⑬	⑭	⑮	
Model number						Selective spec.	Additional spec. (Option)									
Model	0	Welded type straight		For slide type W16 thread 18 (Bulb: φ8), W20 thread 16 (Bulb: φ10), W22 thread 14 (Bulb: φ13)												
	1	Welded type straight		Inside screws W22 thread 14												
	2	Welded type straight		Inside screws Rc1/2												
	3	Welded type straight		Inside screws 1/2NPT												
	4	Welded type straight		Inside screws G1/2												
	5	Welded type straight		Inside screws Rc3/4												
①② Connection	00	R1/2			06	JIS10K25ARF			0M	JIS10K20AFF						
	01	R3/4			07	ANSI 1B150RF			0N	JIS10K25AFF						
	02	1/2NPT			08	ANSI 1B300RF			0P	ANSI 3/4 150RF						
	03	G1/2B			0F	JIS10K15ARF			0Q	ANSI 3/4 300RF						
	04	G3/4B			0G	JIS10K40ARF			0S	ANSI 1 1/2 150RF						
	0C	R1			0H	JIS10K50ARF			0T	ANSI 1 1/2 300RF						
	0D	3/4NPT			0J	JIS20K20ARF			0W	JPI 1 150RF						
	0E	1NPT			0K	JIS20K25ARF			0X	JPI 1 300RF						
	05	JIS10K20ARF			0L	JIS10K15AFF										
③ Material	1	SUS304														
	2	SUS316														
④ Outer DIA.	1	Outer DIA. φ 12 (Bulb inner DIA. for φ 8)														
	2	Outer DIA. φ 15 (Bulb inner DIA. for φ 10)														
	3	Outer DIA. φ 19 (Bulb inner DIA. for φ 13)														
⑤ L length (mm)	SUS304		SUS316													
	0	A	to 100													
	1	B	101 to 200													
	2	C	201 to 300													
	3	D	301 to 400													
	4	E	401 to 500													
	5	F	501 to 600													
	6	G	601 to 700													
	7	H	701 to 800													
	8	J	801 to 900													
	9	K	901 to 1000													
			1001 to (/100mm)													
⑮ Documents	0	Nil														
	1	Required (Please specify the desired documents separately.) Submission drawings, mill sheet														

Please specify thermo-well length. →

* For inside screws other than the above, please contact us

• No oil & no water treatment are available.

* Specify "X" if there is no specification item.

Drilled type

Model number configuration

Please specify the model number and each specs for ordering.

Model

S **W** — () () () — () () × × × × × × × × × () ()

Drilled Type Thermo-well (1) (2) (3) (4) (5) (6) (7) (8) (9) (10) (11) (12) (13) (14) (15)

Model number		Selective spec.		Additional spec. (Option)	
Model	4	0	Drilled type straight	For slide type	W16 thread 18 (Bulb: φ8), W20 thread 16 (Bulb: φ10), W22 thread 14 (Bulb: φ13)
	4	1	Drilled type straight	Inside screws	W22□14
	4	2	Drilled type straight	Inside screws	Rc1/2
	4	3	Drilled type straight	Inside screws	1/2NPT
	4	4	Drilled type straight	Inside screws	G1/2
	4	5	Drilled type straight	Inside screws	Rc3/4
	7	0	Drilled type taper	For slide type	W16 thread 18 (Bulb: φ8), W20 thread 16 (Bulb: φ10), W22 thread 14 (Bulb: φ13)
	7	1	Drilled type taper	Inside screws	W22□14
	7	2	Drilled type taper	Inside screws	Rc1/2
	7	3	Drilled type taper	Inside screws	1/2NPT
	7	4	Drilled type taper	Inside screws	G1/2
7	5	Drilled type taper	Inside screws	Rc3/4	

①② Connection		⑤ L length (mm)		⑤ Documents	
00	R1/2	0	A	ア	to 100
01	R3/4	1	B	イ	101 to 200
02	1/2NPT	2	C	ウ	201 to 300
03	G1/2B	3	D	エ	301 to 400
04	G3/4B	4	E	オ	401 to 500
0B	R3/8 (φ 12 only)	5	F	カ	501 to 600
0C	R1	6	G	キ	601 to 700
0D	3/4NPT	7	H	ク	701 to 800
0E	1NPT				
05	JIS10K20ARF				
06	JIS10K25ARF				
07	ANSI 1B150RF				
08	ANSI 1B300RF				
0G	JIS10K40ARF				
0H	JIS10K50ARF				
0J	JIS20K20ARF				
0K	JIS20K25ARF				
0M	JIS10K20AFF				
0N	JIS10K25AFF				
0P	ANSI 3/4 150RF				
0Q	ANSI 3/4 300RF				
0S	ANSI 1 1/2 150RF				
0T	ANSI 1 1/2 300RF				
0W	JPI 1 150RF				
0X	JPI 1 300RF				

③ Material * 1	
1	SUS304
2	SUS316
5	SUS316L

④ Outer DIA.	
1	Outer DIA. φ 12 (Bulb inner DIA. for φ 8)
2	Outer DIA. φ 15 (Bulb inner DIA. for φ 10)
3	Outer DIA. φ 19 (Bulb inner DIA. for φ 13)
4	Outer DIA. φ 23 (Bulb inner DIA. for φ 16)
5	Outer DIA. φ 19/23 (Bulb inner DIA. for φ 13)
	Specified outer DIA.

Please specify thermo-well length. →

⑤ Documents	
0	Nil
1	Required (Please specify the desired documents separately.) Submission drawings, mill sheet, strength calculation

* 1 For drilled type, titanium, Hastelloy® and other special materials are also available. Please specify the material.

* No oil & no water treatment are available.

* Please contact us for JIS10K15A RF/FF.

* For inside screws other than the above, please contact us

【Manufacturing range】

Manufacturing range of connecting screws and well
 3/8 : Well outer diameter φ12 drilling only
 1/2 : Well outer diameter φ12, φ15
 3/4, 1 : Well outer diameter φ12, φ15, φ19, φ23, φ19/23

* Specify "X" if there is no specification item.

Welded type, flange general-purpose type

Flange general-purpose type specifications

Types and dimensions

Please weld the pipe and flange the following figure.

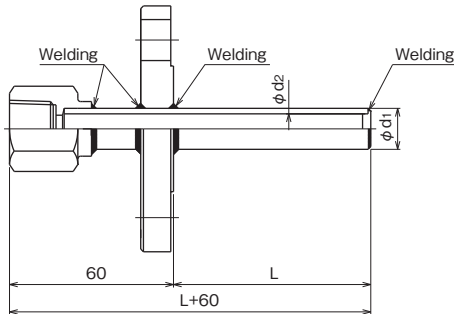

Relation of thermo-well DIA. and bulb DIA., manufacturing range flange

Outer DIA. (d ₁)	Type	Inner DIA. (d ₂)	Bulb outer DIA. (d)	Flange
				JIS, ANSI, JPI
φ 12	Welded type	φ 8.5	φ 8	○
φ 15		φ 11	φ 10	○
φ 19		φ 13.5	φ 13	○

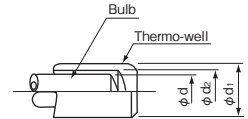

Inside screws (Connecting screws with thermometer): W22 thread 14 or Rc½

Thermo-well material

SUS304

Model number configuration

Please specify the model number and each specs for ordering.

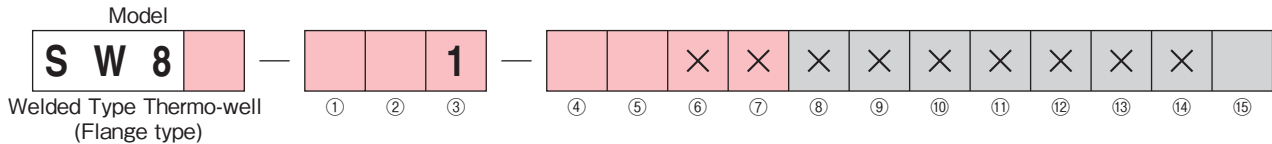

Model number	Selective spec.	Additional spec. (Option)
1	Welding type straight	Inside screws W22 thread 14
2	Welding type straight	Inside screws Rc1/2

①② Connection	③ Material	④ Outer DIA.	⑤ L length (mm)	⑮ Documents
05	1	1	0	0
06		2	1	1
07		3	2	
08			3	
0F			4	
0G			5	
0H			6	
0J			7	
0K			8	
			9	
			1001 to (/100mm)	

Please specify thermo-well length. →

• No oil & no water treatment are available.

*Specify "X" if there is no specification item.